



User's Manual

Indoor Unit :AHE36-1-C,AHE60-1-C



RECOGNIZE THIS SYMBOL AS A SAFETY PRECAUTION

ATTENTION INSTALLING PERSONNEL

Prior to installation, thoroughly familiarize yourself with this Installation Manual. Observe all safety warnings.

During installation or repair, caution is to be observed

It is your responsibility to install the product safely and to educate the customer on its safe use

12201 N.W. 107th Avenue, Medley, FL 33178

www.comfortstarusa.com

INSTALLATION and OWNER'S MANUAL

INDOOR SPLIT-SYSTEM UNIT
MODELS:10 SEER-MVA SERIES
1.5 TO 5 TONS

CONTENTS

SAFETY.....	2
SAFETY REQUIREMNTS.....	2
GENERAL INFORMATION.....	2
INSPECTION.....	2
CLEARANCES.....	2
LOCATION.....	2
ACCESSORIES.....	3
OPERATING TEMPERATURE.....	3
DUCT CONNECTIONS.....	4
DRAIN CONNECTIONS.....	4
ORIFICE INSTALLATION.....	5
REFRIGERANT LINE CONNECTION.....	5
CLEANING THE AIR FILTER.....	6
COIL ASSEMBLY.....	6
MAINTENANCE.....	6
WIRE.....	6
LED DISPLAY.....	7
TEMPERATURE SENSOR.....	7
OPERATIONAL FAULT CODES.....	7
COOLING ONLY ELECTRIC WIRING GAUGE.....	7
COOLING&HEATING ELECTRIC WIRING GAUGE.....	9
DC INVERTER UNIT ELECTRIC WIRING GAUGE.....	10

SAFETY

A This is a safety alert symbol. When you see this symbol on labels or in manuals, be alert to the potential for personal injury. Understand and pay particular attention to the signal words **DANGER**, **WARNING**, or **CAUTION**.

DANGER indicates an imminently hazardous situation, which, if not avoided, **will result in death or serious injury**.

WARNING indicates a potentially hazardous situation, which, if not avoided, **could result in death or serious injury**.

CAUTION indicates a potentially hazardous situation, which, if not avoided, **may result in minor or moderate injury**. It is also used to alert against unsafe practices and hazards involving only property damage.

A WARNING

Improper installation may create a condition where the operation of the product could cause personal injury or property damage. Improper installation, adjustment, alteration, service or maintenance can cause injury or property damage. Refer to this manual for assistance or for additional information, consult a qualified contractor, installer or service agency.

A CAUTION

This product must be installed in strict compliance with the enclosed installation and any applicable local, state, and national codes including, but not limited to building, electrical, and mechanical codes.

A DANGER

Failure to follow the safety warnings exactly could result in serious injury, death or property damage. A fire or electrical hazard may result causing property damage. Personal injury or loss of life.

This appliance can be used by children aged from 8 years and above and persons with reduced physical, sensory or mental capabilities or lack of experience and knowledge if they have been given supervision or instruction concerning use of the appliance in a safe way and understand the hazards involved. Children shall not play with the appliance. Cleaning and user maintenance shall not be made by children without supervision.

This appliance is not intended for use by persons (including children) with reduced physical, sensory or mental capabilities, or lack of experience and knowledge, unless they have been given supervision or instruction concerning use of the appliance by a person responsible for their safety.

Children should be supervised to ensure that they do not play with the appliance.

If the supply cord is damaged, it must be replaced by the manufacturer, its service agent or similarly qualified persons in order to avoid a hazard.

The appliance shall be installed in accordance with national wiring regulations.

Do not operate your air conditioner in a wet room such as a bathroom or laundry room.

An all-pole disconnection device which has at least 3mm Clearances in all poles, and have a leakage current that may exceed 10mA, the residual current device (RCD) having a rated residual operating current not exceeding 30 mA, and disconnection must be incorporated in the fixed wiring in accordance with the wiring rules.

1. Install this air handler only in a location and position as specified in this instruction.
2. Always install the air handler to operate within the air handler's intended temperature rise range. Only connect the air handler to a duct system which has an external static pressure within the allowable range, as specified on the air handler rating plate.

3. When an air handler is installed so that supply ducts carry air circulated by the air handler to areas outside the space containing the air handler, the return air shall also be handled by duct(s) Sealed to the air handler casing and terminating outside the space containing the air handler.

4. The size of the unit should be based on an acceptable heat loss calculation for the structure. ACCA Manual J or other approved methods may be used.

SAFETY REQUIREMENTS

1. This air handler should be installed in accordance with all national and local building/safety codes and requirements, local plumbing or waste water codes, and other applicable codes.
2. Refer to the unit rating plate for the air handler model number, and then see the dimensions page of this instruction for supply air plenum dimensions in Figure 2. The plenum must be installed according to the instructions.
3. Provide clearances from combustible materials as listed under Clearances to Combustibles.
4. Provide clearances for servicing ensuring that service access is allowed for both the burners and blower.
5. This air handler is not approved for installation in trailers or recreational vehicles.
6. Failure to carefully read and follow all instructions in this manual can result in air handler malfunction, death, personal injury and/or property damage.
7. Check the rating plate and power supply to be sure that the electrical characteristics match.
8. Air handler shall be installed so the electrical components are protected from water.
9. These instructions cover minimum requirements and conform to existing national standards and safety codes. In some instances these instructions exceed certain local codes and ordinances, especially those who have not kept up with changing residential and non-HUD modular home construction practices. These instructions are required as a minimum for a safe installation.

GENERAL INFORMATION

This Modular Air Handler provides the flexibility for installation in any Up-flow or horizontal application. See Figures 1. The direct drive motors provide a selection of air volume to match any application. The unit can be positioned for bottom return air in the upflow position, left return in the horizontal position.

Top and side power wiring and control Wiring, accessible screw terminals for control wiring all combine to make the installation easy, and minimize installation cost.

INSPECTION

As soon as a unit is received, it should be inspected for possible damage during transit. Also, before installation the unit should be checked for screws or bolts, which may have loosened in transit. There are no shipping or spacer brackets which need to be removed.

Also check to be sure all accessories and coils are available. Installation of these accessories or field conversion of the unit should be accomplished before setting the unit in place or connecting any wiring, electric heat, ducts or piping.

CLEARANCES

1. Refrigerant piping and connections - minimum 12" recommended.
2. Maintenance and servicing access - minimum 36" from front of unit recommended for blower motor/coil replacement.
3. Condensate drain line.
4. Filter removal - minimum 36" recommended.

LOCATION

Location is usually predetermined. Check with owner's or dealer's installation plans, if location has not been decided, consider the location in choosing a suitable location.

1. Select a location with adequate structural support, space for service

- access, clearance or air return and supply duct connections.
- Use hanging brackets to waft mount unit as shown below.
 - Normal operating sound levels may be objectionable if the air handler is placed directly over some rooms such as bedrooms, study, etc.
 - Precautions should be taken to locate the unit and duct work so that supply air does not short circuit to the return air.
 - Select a location that will permit installation of condensate line to an open drain.

NOTE: When the coil is installed in a draw-thru application, it is recommended to trap the primary and secondary drain line. If the secondary drain line is not used, it must be capped.



The coil is provided with a secondary drain, it should be piped to a location that will give the occupant a visual warning that the primary drain is clogged. If the secondary drain is not used it must be capped.

- When an evaporator coil is installed in an attic or above a finished ceiling, an auxiliary drain pan should be provided under the coil as is specified by most local building codes.
- Proper electrical supply must be available.
- Clearances must also be taken into consideration, and provided for as follows:

- Refrigerant piping and connections are located in the front.
- Maintenance and servicing through the front or access side of unit with both sides and rear of unit having zero inch clearance.
- Condensate drain lines are connected in the front (clear of filter).
- Filter removal.
- When no electric heat is used, the unit as well as all duct work and plenum are designed for zero clearance to combustible materials.

ACCESSORIES

Please check whether the following fittings are of full scope. If there are some spare fittings, please restore them carefully.

NO.	Part Name	Quantity	Illustrations
1	Seal ring	2	
2	Drain joint	1	

OPERATING TEMPERATURE

Mode	Cooling operation	Heating operation	Drying operation
Room temperature	17°C ~ 32°C (62°F ~ 90°F)	0°C ~ 30°C (32°F ~ 86°F)	17°C ~ 32°C (62°F ~ 90°F)
Outdoor temperature	18°C ~ 43°C (64°F ~ 109°F)	-7°C ~ 24°C (20°F ~ 76°F)	18°C ~ 43°C (64°F ~ 109°F)
	-7°C ~ 43°C (20°F ~ 109°F) : For the models with low temperature cooling system		18°C ~ 52°C (64°F ~ 126°F) : For special tropical models
	18°C ~ 52°C (64°F ~ 126°F) : For special tropical models		

CAUTION :

- If air conditioner is used outside of the above conditions, Certain safety protection features may come into operation and cause the unit to function abnormally.
- Room relative humidity less than 80%. If the air conditioner operates in excess of this figure, the surface of the air conditioner may attract condensation. Please sets the vertical air flow 1ouwer to its maximum angle (vertically to the floor), and set HIGH fan mode.
- Optimum performance will be achieved within these operating temperature.

FIGURE 1 : Typical Applications with MVA Multi-Position Coils

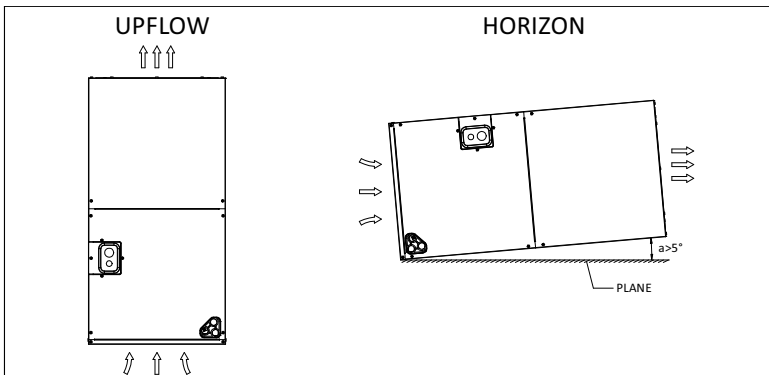

FIGURE 2:Plenum Clearances

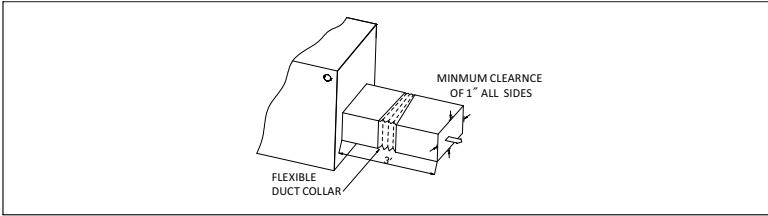

FIGURE 3:Dimensions and Duct Sizes

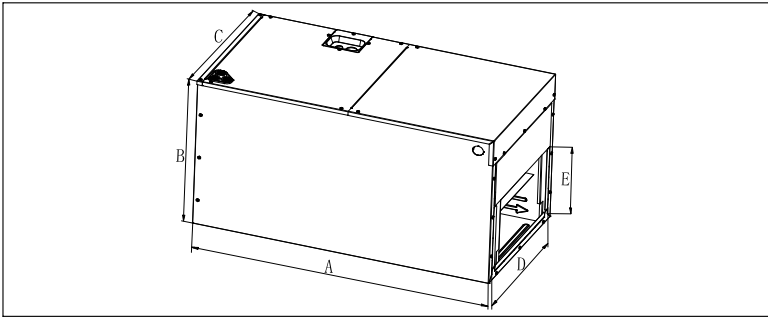

TABLE 1:Dimensions

MODEL	Dimensions(mm)				
	A(Height)	B(Depth)	C(Width)	D	E
18	774	520	460	414	245
24	774	520	460	414	245
36	774	520	460	414	245
48	970 (1160)	550	500	454	266
60	970 (1160)	550	500	454	266

Note: (1160) is custom model’s height.

DUCT CONNECTIONS

Air supply and return may be handled in one of several ways best suited to the installation(See Figure 3 and table 1 for dimensions for duct inlet and outlet connections).

The vast majority of problems encountered with combination cooling systems can be linked to improperly designed or installed duct systems, it is therefore highly important to the success of an installation that the duct system be properly designed and installed.

Use flexible duct collars to minimize the transmission of vibration/noise into the conditioned space.

Where-return air duct is short, or where sound is liable to be a problem, sound absorbing glass fiber should be used inside the duct.Insulation of duct work is a must where it runs through an uncooled space during the cooling season. The use of a vapor barrier is recommended to prevent absorption of moisture from the surrounding air into the insulation. The supply air duct should be properly sized by use of a transition to match unit opening.All ducts should be suspended using

Flexible hangers and never fastened directly to the structure.This unit is not designed for non-ducted(freeblow)applications.

Duct work should be fabricated and installed in accordance with local and/or national codes.

DRAIN CONNECTIONS

All drain lines should be trapped a minimum of three inches,should be pitched away from unit drain Pan and Should be no smaller than the coil drain connection.

CAUTION

Drain connection should be hand-tightened,plus no more than 1/16 turn.

FIGURE 4: Drain connection

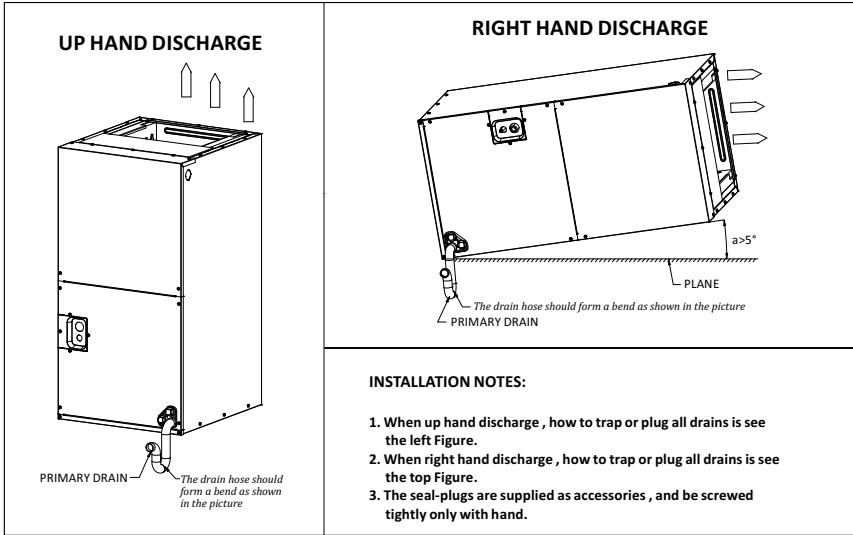

INSTALLATION NOTES:

1. When up hand discharge, how to trap or plug all drains is see the left Figure.
2. When right hand discharge, how to trap or plug all drains is see the top Figure.
3. The seal-plugs are supplied as accessories, and be screwed tightly only with hand.

CAUTION

Horizontal drain cutout in the center access panel should be removed by using a utility knife. DO NOT TRY TO KNOCK OUT.

Route the drain line so that it does not interfere with accessibility to the coil, air handling system or filter and will not be exposed to freezing temperatures. See Figures 1, 2 and 3.

NOTE: When the coil is installed in an attic or above a finished ceiling, an auxiliary drain pan should be provided under the coil as is specified by most local building codes.

Coils Should be installed level or pitched slightly toward the drain end. Suggested pitch should not exceed 1/4 inch per foot of coil. The coil is provided with a secondary drain that should be trapped and piped to a location that will give the occupant a visual warning that the primary drain is clogged. If the secondary drain is not used it must be capped. The drain pan connections are designed to ASTM Standard D 2466 Schedule 40, Use 3/4" PVC or steel threaded pipe. Since the drains are not subject to any pressure it is not necessary to use Schedule 40 pipe for drain lines.

It is recommended that all drain connections be sealed with teflon tape or equivalent.

ORIFICE INSTALLATION

A standard orifice is preinstalled in the unit and is marked on the unit data plate. Refer to the outdoor unit instruction and application data to determine the proper orifice required for your particular system combination and piping conditions.

If the orifice sizes match, nothing further is required and the refrigerant lines may be connected per the outdoor unit instruction. However, if another orifice should be used, change the orifice in the coil with the following procedure:

CAUTION

This fitting is a right-hand thread, turn counter-clockwise to remove.

1. Remove the liquid line fitting using 3/4" wrenches, and remove the preinstalled orifice with a small diameter wire or paper clip.
2. Remove the new orifice from the packet and verify that it is the correct number required. Install this orifice with the rounded end toward the coil and the flat end outward.
3. Thread the liquid line fitting back in place on the coil. Tighten the fitting hand tight and turn an additional 1/8 turn to seal.

CAUTION

Use wrenches to turn fittings. Using pliers will cause internal damage to the fitting.

- NOTE: This procedure should be done within 2 minutes to keep air and contaminants from entering the coil. If the orifice cannot be replaced and the coil resealed within 2 minutes, then it should be temporarily closed to air using masking tape (short term delay) or plugging/capping (long term delay). There is no need to purge the coil if this procedure is done within the time limit.
4. Mark the data plate with the orifice installed.

REFRIGERANT LINE CONNECTION

See the outdoor unit installation instructions for the procedure to install field supplied tubing for systems with sweat fittings.

Connect lines as follows:

NOTE: Route the refrigerant lines to the coil in a manner that will not obstruct service access to the coil, air handling system or filter.

1. Removing the bottom cover, push up the front cover of pipe.
2. Braze the suction line and the liquid line. See figure 5.
3. Attach the front cover of pipe to bottom cover, reattach the bottom cover.
4. Install supplied grommets on both the suction and liquid lines to complete the air seat.

Line should be sound isolated by using appropriate hangers or strapping. When field supplied lines are used be sure to insulate the liquid line under any conditions where the ambient temperature is greater than the liquid line temperature.

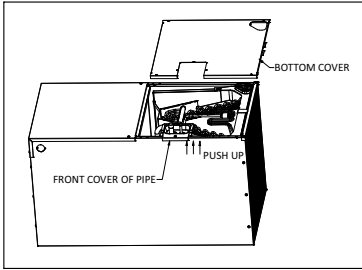

FIGURE 4: Connect the Refrigerant line

CLEANING THE AIR FILTER

- 1.The air filter can prevent the dust or other particulate from going inside. In case of blockage of the filter, the working efficiency of the air conditioner may greatly decrease. Therefore, the filter must be cleaned once two weeks during long time usage.
- 2.If the air conditioner is positioned in a dust place, the cleaning frequency of the air filter must be increased.
- 3.If the accumulated dust is too heavy to be cleaned, please replace the filter with a new one (replaceable air filter is an optional fitting).

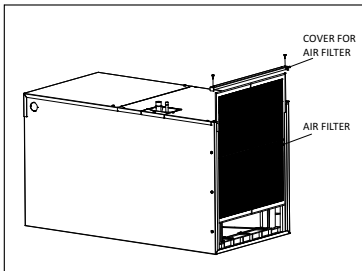

FIGURE 5: Remove The Air Filter

- 1.Tear down the two bolts signed A and B, take down the cover for air filter, see in Figure 6.
- 2.Hold the edge of the air filter and extract out.
- 3.Clean the air filter (Vacuum cleaner or pure water may be used to clean the air filter. If the dust accumulation is too heavy, please use soft brush and mild detergent to clean it and dry out in cool place).

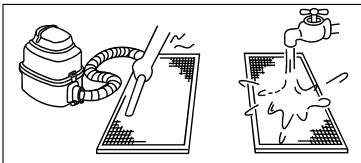

FIGURE 6: Clean The Air Filter

- 4.Install the air filter in the reverse order of step 1 and 2.

⚠ CAUTION

Do not dry out the air filter under direct sunshine or with fire.

COIL ASSEMBLY

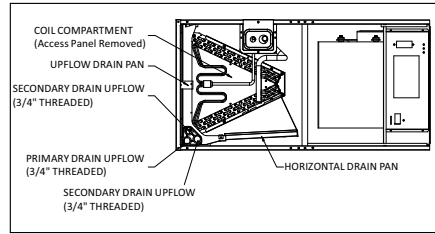

FIGURE 7: Coil Assembly

MAINTENANCE

- 1.Filters must be cleaned or replaced when they become dirty. Inspect at least once per month. The frequency of cleaning depends upon the hours of operation and the local atmospheric conditions. Clean filters keep unit efficiency high.
- 2.If the coil needs to be cleaned or replaced, it should be washed with Calgon coilclean (mix one part coilclean to seven parts water). Allow solution to remain on coil for 30 minutes before rinsing with clean water. Solution should not be permitted to come in contact with painted surfaces.
- 3.The bearings of the blower motor are permanently lubricated.
- 4.During the cooling season check the condensate drain lines to be sure that condensate is flowing from the primary drain but not from the secondary drain, if condensate ever flows from the secondary drain the unit should be promptly shut off and the condensate pan and drains cleaned to insure a free flowing primary drain.

Wire

- 1.To avoid the electric shock, please link the air conditioner with the ground. The plug in the air conditioner has joined the ground wiring, please don't change it freely.
- 2.The power socket is used as the air conditioner specially.
- 3.Don't pull the power wiring hard.
- 4.When linking the air conditioner with the ground; observe the local rules.
- 5.If necessary, use the power fuse or the circuit, breaker or the corresponding scale ampere.

When installing or repair the air condition, relate to system wiring, please operating as follows:

- 1.Tear down the seven bolts in the top cover, see in Figure 8.
- 2.Hold the edge of the top condenser and extract out.
- 3.Install the top condenser in the reverse order of step 1 and 2.

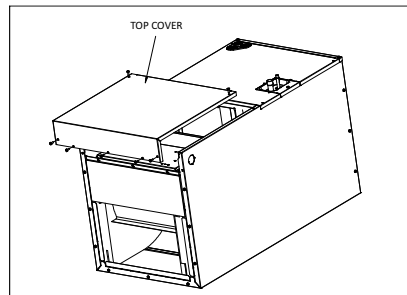

FIGURE 8: Remove The Top Cover

COOLING ONLY

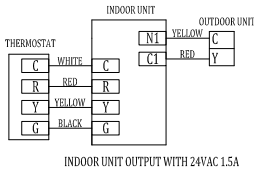

FIGURE 9: Cooling only System Wiring Diagram

Suggestion: thermostat choose Non-programmed electrical thermostat series of Honeywell, such as Th5220D

LED DISPLAY

The control would display any fault code that is currently active using the LED. The control will display the fault code, when the LEDs are flashing quickly, there is something wrong with the system. Refer to below table for detail fault code.

TEMPERATURE SENSOR

The unit has one temperature sensor, which is called pipe temperature sensor. When the temperature sensor is damaged, the system would close and the LED would be flashing.

NUMBER	CODE	LED1	LED2	LED3
1	EVAPORATOR SENSOR ERROR	☒	★	★
2	Evaporator Anti-freezing protection	☒	☒	★

NOTE: ☒ MEANS LED ON, ★ MEANS LED FLASHES AT 1.0 Hz

POWER WIRING DIAGRAM

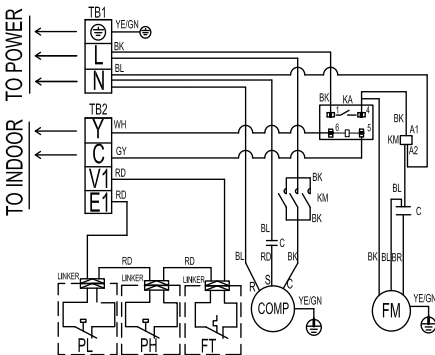

Suggestion: The wire diagram is as FIGURE 10 when the outdoor unit is getting feedback from terminals E1, V1.

Attention: Please use the wire in the part bag.

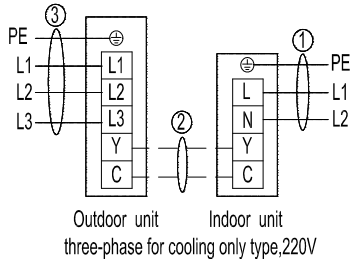
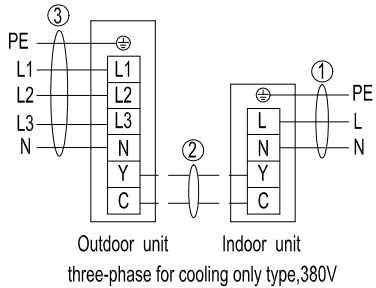
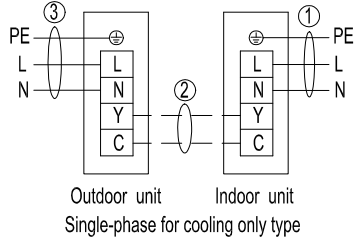

Note: For reference only, the actual wiring diagram shall prevail

COOLING ONLY ELECTRIC WIRING GAUGE

Capacity(Btu/h)		24000 Btu/h	36000 Btu/h	48000 Btu/h	60000 Btu/h	
Power	Indoor	Phase	Single			
		Frequency/Voltage	220-230V,60Hz1PH,220-240,50Hz 1PH			
	Outdoor	Phase	Single			
		Frequency/Voltage	220-230V,60Hz1PH,220-240,50Hz 1PH			
Input Current Fuse	Indoor unit(A)	5A	5A	5A	5A	
Lines Gauge	Indoor Unit	Line Quantity	3	3	3	3
		Power Line	Line Diameter(AWG)	18/1.0mm ²	18/1.0mm ²	18/1.0mm ²
	Outdoor Unit	Line Quantity	3	3	3	3
		Power Line	Line Diameter(AWG)	14/2.5mm ²	12/4.0mm ²	10/6.0mm ²
	Outdoor-Indoor	Line Quantity	2	2	2	2
		Signal Line	Line Diameter(AWG)	18/1.0mm ²	18/1.0mm ²	18/1.0mm ²
	Thermostat	Line Quantity	4	4	4	4
		Signal Line	Line Diameter(AWG)	18/1.0mm ²	18/1.0mm ²	18/1.0mm ²

TABLE2:Wiring Gauge

Capacity(Btu/h)		24000 Btu/h	36000 Btu/h	48000 Btu/h	60000 Btu/h	
Power	Indoor	Phase	Single			
		Frequency/Voltage	220-240V,50/60Hz 1PH			
	Outdoor	Phase	Three			
		Frequency/Voltage	380-420V, 50/60Hz 3PH			
Input Current Fuse	Indoor unit(A)	—	5A	5A	5A	
Lines Gauge	Indoor Unit	Line Quantity	—	3	3	3
		Power Line	Line Diameter(AWG)	—	18/1.0mm ²	18/1.0mm ²
	Outdoor Unit	Line Quantity	—	5	5	5
		Power Line	Line Diameter(AWG)	—	14/2.5mm ²	14/2.5mm ²
	Outdoor-Indoor	Line Quantity	—	2	2	2
		Signal Line	Line Diameter(AWG)	—	18/1.0mm ²	18/1.0mm ²
	Thermostat	Line Quantity	—	4	4	4
		Signal Line	Line Diameter(AWG)	—	18/1.0mm ²	18/1.0mm ²

TABLE3:Wiring Gauge

Capacity(Btu/h)		24000 Btu/h	36000 Btu/h	48000 Btu/h	60000 Btu/h	
Power	Indoor	Phase	Single			
		Frequency/Voltage	220-240V,50/60Hz 1PH			
	Outdoor	Phase	Three			
		Frequency/Voltage	380-420V, 50/60Hz 3PH			
Input Current Fuse	Indoor unit(A)	—	5A	5A	5A	
Lines Gauge	Indoor Unit	Line Quantity	—	3	3	3
		Power Line	Line Diameter(AWG)	—	18/1.0mm ²	18/1.0mm ²
	Outdoor Unit	Line Quantity	—	5	5	5
		Power Line	Line Diameter(AWG)	—	12/4.0mm ²	12/4.0mm ²
	Outdoor-Indoor	Line Quantity	—	2	2	2
		Signal Line	Line Diameter(AWG)	—	18/1.0mm ²	18/1.0mm ²
	Thermostat	Line Quantity	—	4	4	4
		Signal Line	Line Diameter(AWG)	—	18/1.0mm ²	18/1.0mm ²

TABLE4:Wiring Gauge

Note: For reference only, the actual wiring diagram shall prevail

COOLING&HEATING

Cooling&Heating System Wiring Diagram

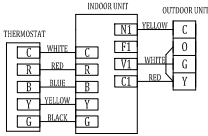

INDOOR UNIT OUTPUT WITH 24VAC 1.5A

Suggestion: thermostat choose Non-programmed electrical thermostat series of Honeywell, such as TH5220D

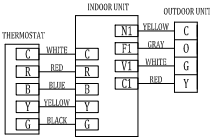

INDOOR UNIT OUTPUT WITH 24VAC 1.5A

POWER WIRING DIAGRAM

There are many kinds of power wiring diagram for different user powers and models, take double-temperature units for examples:

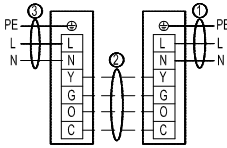

Outdoor unit Indoor unit
Single-phase for cooling and heatpump type

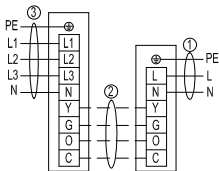

Outdoor unit Indoor unit
three-phase for cooling and heatpump type.380V

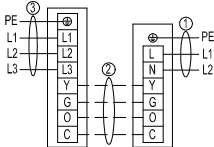

Outdoor unit Indoor unit
three-phase for cooling and heatpump type.220V

Note: For reference only, the actual wiring diagram shall prevail

COOLING&HEATING ELECTRIC WIRING GAUGE:

Capacity(Btu/h)		24000 Btu/h	36000 Btu/h	48000 Btu/h	60000 Btu/h	
Power	Indoor	Phase	Single			
		Frequency/Voltage	220-230V,60Hz 1PH/220-240,50Hz 1PH			
	Outdoor	Phase	Single			
Frequency/Voltage		220-230V,60Hz 1PH/220-240,50Hz 1PH				
Input Current Fuse	Indoor unit(A)	5A	5A	5A	5A	
Line Gauge	Indoor Unit	Line Quantity	3	3	3	3
		Line Diameter(AWG)	18/1.0mm ²	18/1.0mm ²	18/1.0mm ²	18/1.0mm ²
	Outdoor Unit	Line Quantity	3	3	3	3
		Line Diameter(AWG)	14/2.5mm ²	12/4.0mm ²	10/6.0mm ²	10/6.0mm ²
	Outdoor-Indoor	Line Quantity	3	3	3	3
		Line Diameter(AWG)	18/1.0mm ²	18/1.0mm ²	18/1.0mm ²	18/1.0mm ²
	Thermostat	Line Quantity	5	5	5	5
		Line Diameter(AWG)	18/1.0mm ²	18/1.0mm ²	18/1.0mm ²	18/1.0mm ²

TABLE5:Wiring Gauge

Capacity(Btu/h)		24000 Btu/h	36000 Btu/h	48000 Btu/h	60000 Btu/h	
Power	Indoor	Phase	Single			
		Frequency/Voltage	220-240V,50/60Hz 1PH			
	Outdoor	Phase	Three			
Frequency/Voltage		380-420V, 50/60Hz 3PH				
Input Current Fuse	Indoor unit(A)	—	5A	5A	5A	
Line Gauge	Indoor Unit	Line Quantity	—	3	3	3
		Line Diameter(AWG)	—	18/1.0mm ²	18/1.0mm ²	18/1.0mm ²
	Outdoor Unit	Line Quantity	—	5	5	5
		Line Diameter(AWG)	—	14/2.5mm ²	14/2.5mm ²	14/2.5mm ²
	Outdoor-Indoor	Line Quantity	—	3	3	3
		Line Diameter(AWG)	—	18/1.0mm ²	18/1.0mm ²	18/1.0mm ²
	Thermostat	Line Quantity	—	5	5	5
		Line Diameter(AWG)	—	18/1.0mm ²	18/1.0mm ²	18/1.0mm ²

TABLE6:Wiring Gauge

Capacity(Btu/h)		24000 Btu/h	36000 Btu/h	48000 Btu/h	60000 Btu/h	
Power	Indoor	Phase	Single			
		Frequency/Voltage	220-240V,50/60Hz 1PH			
	Outdoor	Phase	Three			
Frequency/Voltage		380-420V, 50/60Hz 3PH				
Input Current Fuse	Indoor unit(A)	—	5A	5A	5A	
Line Gauge	Indoor Unit	Line Quantity	—	3	3	3
		Line Diameter(AWG)	—	18/1.0mm ²	18/1.0mm ²	18/1.0mm ²
	Outdoor Unit	Line Quantity	—	5	5	5
		Line Diameter(AWG)	—	12/4.0mm ²	12/4.0mm ²	10/6.0mm ²
	Outdoor-Indoor	Line Quantity	—	3	3	3
		Line Diameter(AWG)	—	18/1.0mm ²	18/1.0mm ²	18/1.0mm ²
	Thermostat	Line Quantity	—	5	5	5
		Line Diameter(AWG)	—	18/1.0mm ²	18/1.0mm ²	18/1.0mm ²

TABLE7:Wiring Gauge

ComfortStar®

The design and specifications are subject to change without prior notice for product improvement. Consult with the sales agency or manufacturer for details.