

ComfortStar Model:  
Power Supply :

AHU48  
208-230V/1Ph/60HZ

ComfortStar®

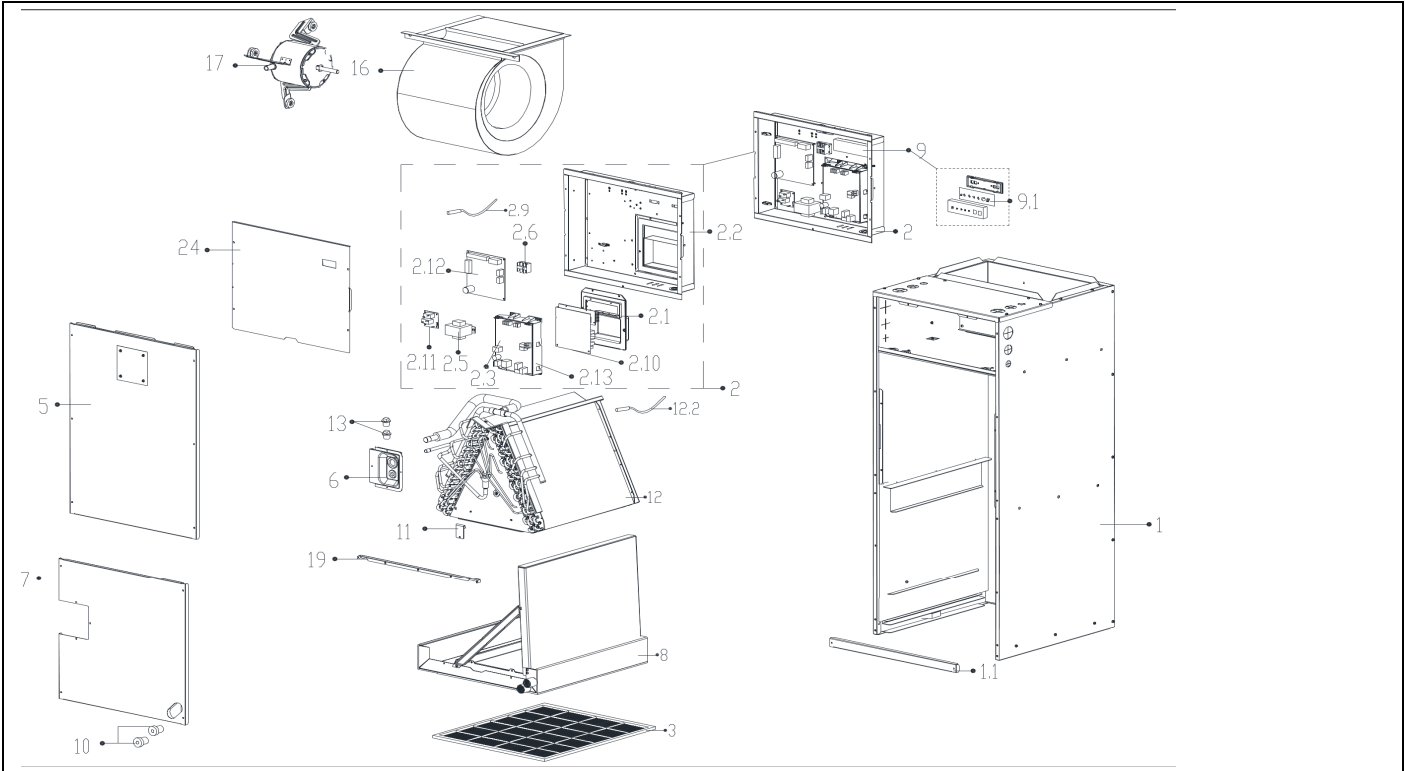

No.	Part Name	Quantity	BOM Code
1	Chassis subassembly	1	12223000012117
1.1	Filter filter clamp	1.0	12223000012116
2	Duct electronic control box subassembly	1	17223000006617
2.2	Electronic control box	1.0	12223000012109
2.3	Duct main control board subassembly	1.0	17123000006157
2.5	Linear Transformer	1.0	11203103000087
2.6	Wire joint	1.0	17400401000085
2.9	Room Temperature Sensor	1.0	11201007003563
2.10	Inverter control board subassembly	1.0	17122000048529
2.11	Auxiliary electric heater control board subassembly	1.0	17117600000064
2.12	Data transfer module control board printed board subassembly	1.0	17122000048527
2.13	Insulation plate	1.0	12123000000800
3	Air filter	1	12223000012332
5	Upside board subassembly	1	12223000012118
6	Pipe clamp board subassembly	1	12223000012110
7	Underside board subassembly	1	12223000012108
8	Water collector subassembly	1	12223000012115
9	Duct display board subassembly	1	17223000006618
9.1	Duct display board subassembly	1.0	17123000004237
10	Seal stopper	2	12623000000194
11	Fixing board of water collector	1	12223000000028
12	Evaporator assembly	1	15823100000482
12.2	Pipe Temperature Sensor	1.0	11201007003437
13	Rubber seal	1	12600801000001
13	Rubber seal	1	12600801000002
16	centrifuge fan assembly	1	12200101000253
17	Brushless DC Motor	1	11002015010886
19	Supporting bar	1	12223100000197
24	Electric control box cover	1	12223000012120
25	Remote controller for AHU settings	1	17317000A04396