

ComfortStar Model Number: CIM12CD(O)

Power Supply: 208-230V/60Hz/1Ph

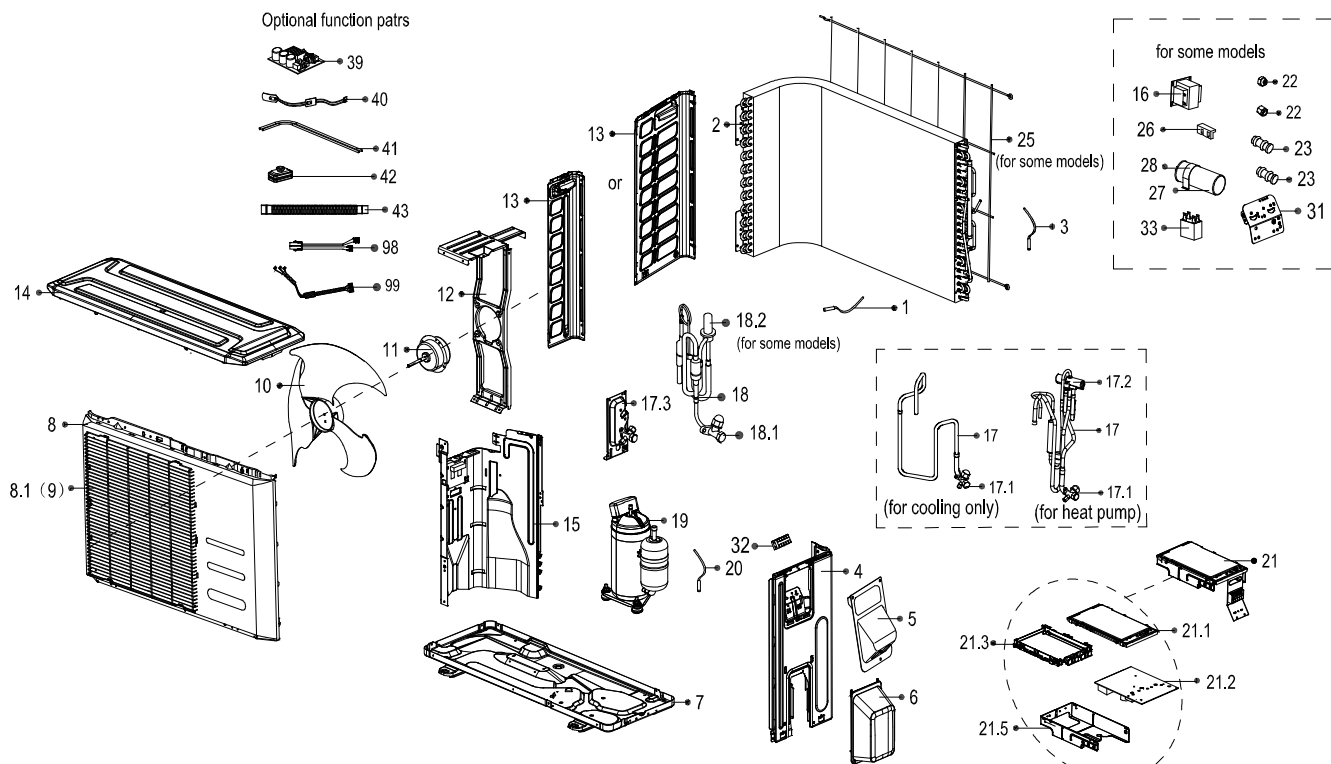

No.	Part Name	Quantity	PART#
1	Room Temperature Sensor	1	11201007002321
2	Condenser Assembly	1	15822000006597
3	Pipe Temperature Sensor	1	11201007002320
4	Right Clapboard Assembly	1	12222000006249
5	Big Handle Assembly	1	12222000005102
6	Water Collector	1	12122000007150
7	Chassis Assembly	1	12222000004427
8	Front Panel Assembly	1	12222000004842
9	Air Outlet Grille	1	12222000007424
10	Axial Flow Fan	1	12100105000057
11	Brushless Dc Motor	1	110020150006761
12	Supporter Subassembly Of Fan Motor	1	12222000008924
13	Left Supporter	1	12222000006244
14	Top Cover Assembly	1	12222000006246
15	Partition Board	1	12222000004425
17	Gas Valve Assembly	1	15422000013752
17.1	Gas Valve	1	15500204000058
17.3	Valve Plate	1	12222000002571
18	Liquid Valve Assembly	1	15422000005282
18.1	Liquid Valve	1	15500208000028
19	Dc Inverter Rotary Compressor	1	11103020003119
20	Discharge Temperature Sensor	1	11201007000005
21	Electronic Control Box Subassembly	1	17222000024573
21.1	Cover Of Electronic Control Box	1	12222000001455
21.2	Outdoor Main Control Board Subassembly	1	17122000038455
21.3	Support Of Electronic Control Box	1	12122000006913
21.5	Electronic Installing Box Subassembly	1	12222000001311
22	Copper nut for 1/2 Pipe (12.7mm)	1	15500406000012
22	Copper nut for 1/4 Pipe (6.35mm)	1	15500406000016
25	Rear Net	1	12222000003986
31	Terminal Board	1	12222000002259
32	Wire Joint	1	17400401000075
99	Compressor Wire Subassembly	1	17401203000802