

ComfortStar Model Number: CIM18CD(I)

Power Supply: 208-230V/60Hz/1Ph

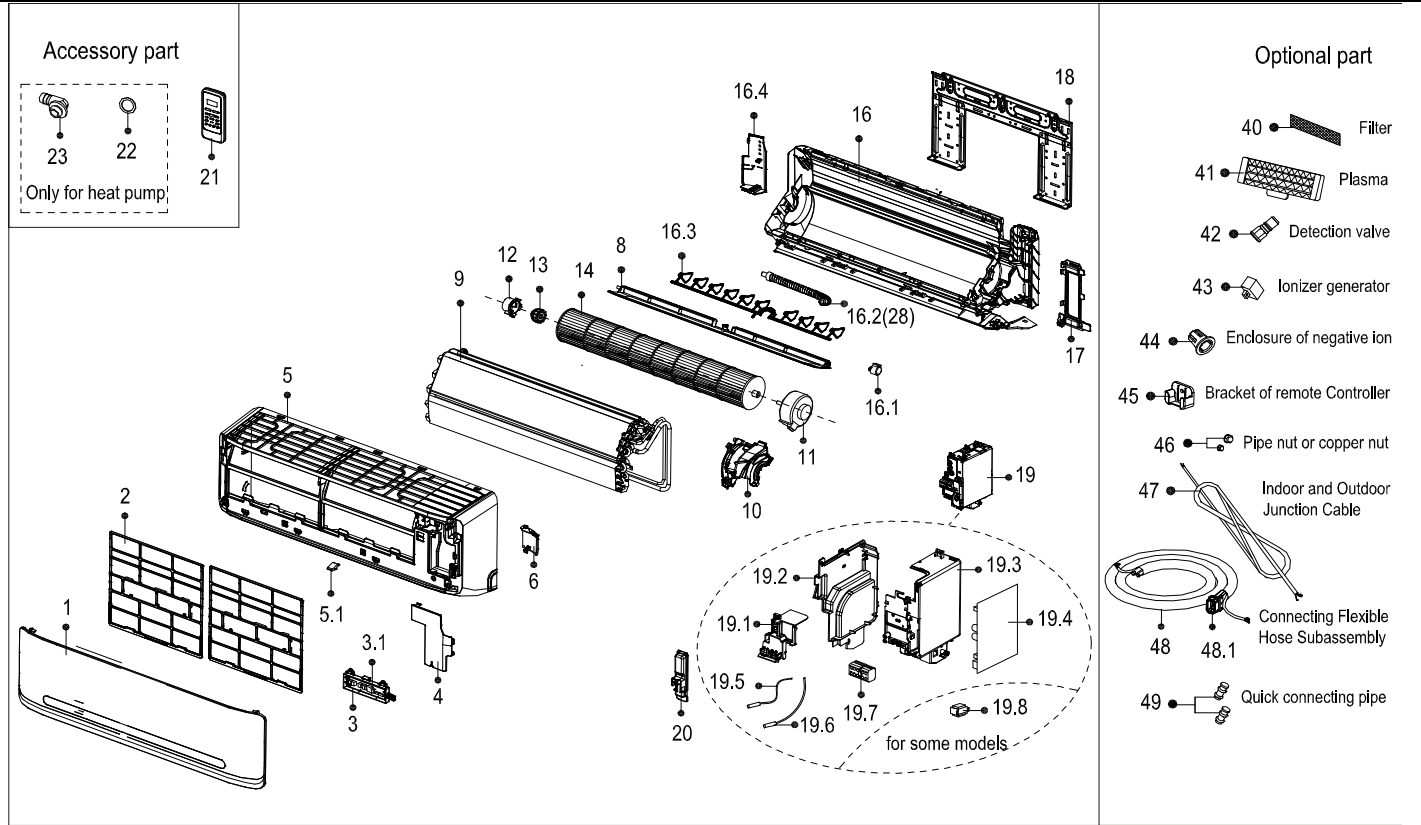

No.	Part Name	Quantity	PART#
1	Panel Assembly	1	12122000001157
2	Air Filter	2	12100204000479
3	Display Box Subassembly	1	17222000002878
3.1	Display Board Subassembly	1	17122000006953
4	Cover Of Electrical Equipment	1	12122000006755
5	Panel Frame Assembly	1	12122000001894
5.1	Screw Cap	1	12122000008242
6	Right Cover Plate Of Chassis	1	12122000004587
8	Horizontal Louver Assembly	1	12122000008055
9	Evaporator Assembly	1	15822000000204
10	Fan Motor Cover	1	12122000005540
11	Single Phase Asynchronous Motor	1	11002012001871
12	Bearing Holder	1	12122000000350
13	Bearing Base	1	12622000000006
14	Cross Flow Fan	1	12100102000070
16	Chassis Assembly	1	12122000012359
16.1	Stepper Motor	1	11002010000143
16.3	Vertical Vane Subassembly	1	12122000000039
16.4	Front Cover Of Chassis(Left)	1	12122000010098
17	Pipe Clamp Board	1	12122000012943
18	Installation Plate	1	12222000000018
19	Electronic Control Box Subassembly (Mid-And Low-End)	1	17222000010950
19.1	Electronic Control Box	1	12122000004577
19.2	Left Cover Of Electronic Control Box	1	12122000004639
19.3	Right Cover Of Electronic Control Box	1	12122000004632
19.4	Main Control Board Subassembly	1	17122000020574
19.5	Room Temperature Sensor	1	11201007000085
19.6	Pipe Temperature Sensor	1	11201007000322
19.7	Wire Joint	1	17400401000006
20	Cover Of Electronic Control Box	1	12122000005020
21	Remote Controller	1	17317000001294
28	Drain Hose	1	12100501000032
40	Air Fresh Filter	1	12100204000685
46	Copper nut for 1/4 Pipe (6.35mm)	1	15500406000016
46	Copper nut for 3/8 Pipe (9.52mm)	1	15500406000010