

ComfortStar Model: AHU24
 Power Supply : 208-230V/1Ph/60HZ

ComfortStar®

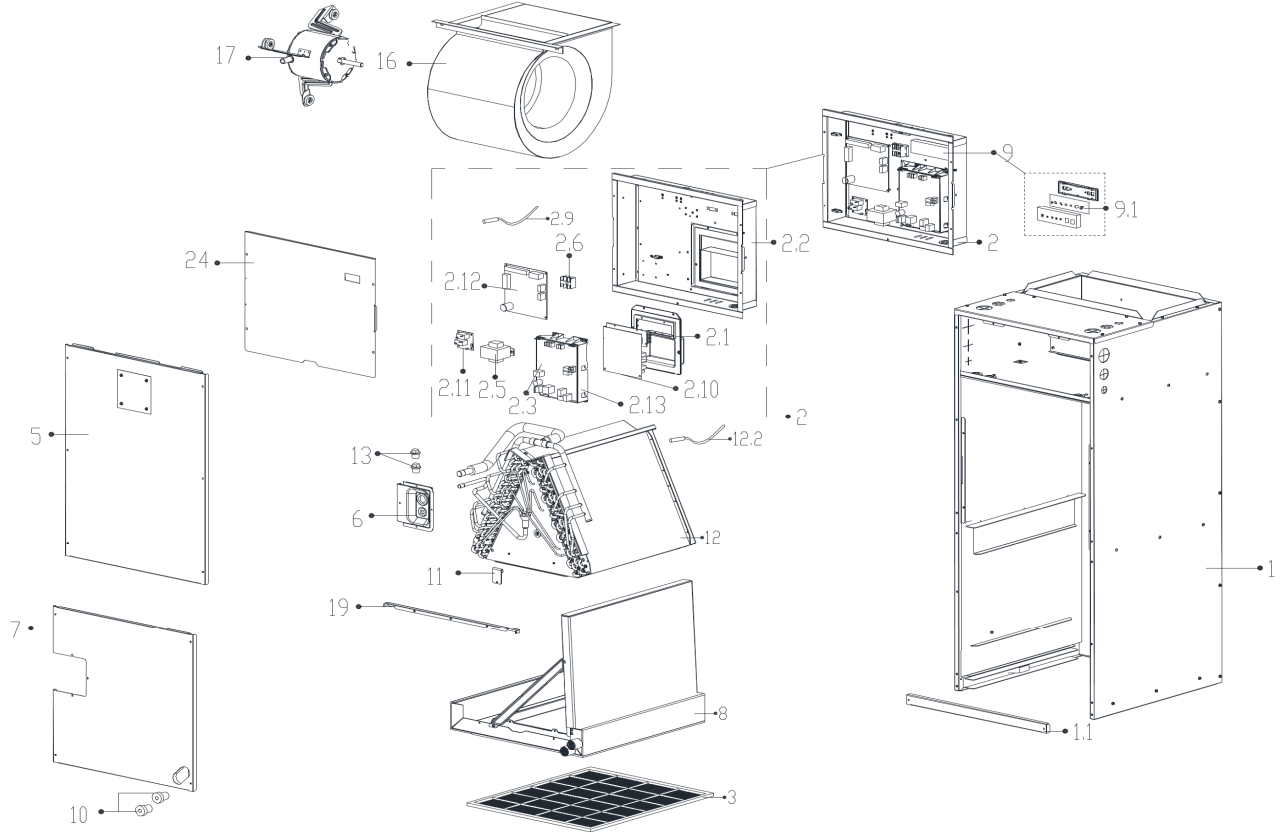

No.	PART#	Part Name	Quantity
1	12223000012117	Chassis subassembly	1
1.1	12223000012116	Filter filter clamp	1
2	17223000006619	Duct electronic control box subassembly	1
2.2	12223000012109	Electronic control box	1
2.3	17123000006162	Duct main control board subassembly	1
2.5	11203103000087	Linear Transformer	1
2.6	17400401000097	Wire joint	1
2.9	11201007003563	Room Temperature Sensor	1
2.10	17122000048529	Inverter control board subassembly	1
2.11	17117600000064	Auxiliary electric heater control board subassembly	1
2.12	17122000048532	Data transfer module control board printed board subassembly	1
2.13	12123000000800	Insulation plate	1
3	12223000012332	Air filter	1
5	12223000012118	Upside board subassembly	1
6	12223000012110	Pipe clamp board subassembly	1
7	12223000012108	Underside board subassembly	1
8	12223000012115	Water collector subassembly	1
9	17223000006618	Duct display board subassembly	1
9.1	17123000004237	Duct display board subassembly	1
10	12623000000194	Seal stopper	2
12	15823100000483	Evaporator assembly	1
12.2	11201007003437	Pipe Temperature Sensor	1
13	12600801000001	Rubber seal1	1
13	12600801000002	Rubber seal2	1
16	12200101000253	centrifuge fan assembly	1
17	11002015010886	Brushless DC Motor	1
19	12223100000197	Rear support board	1
24	12223000012120	Electric control box cover	1