

# Exploded View

Model

CWM5-36-15

ComfortStar®

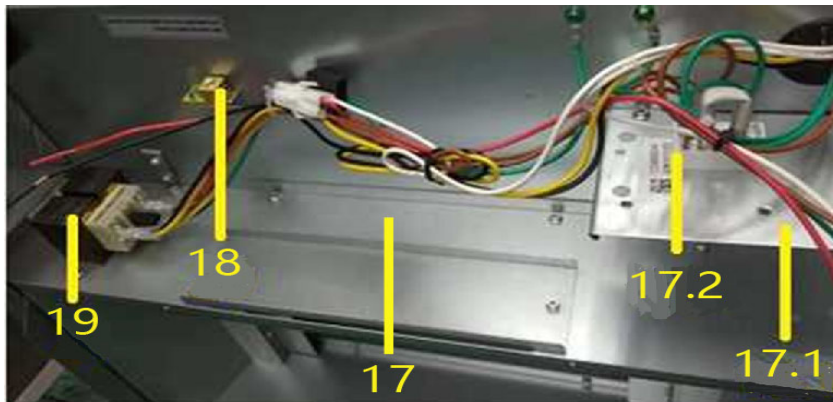
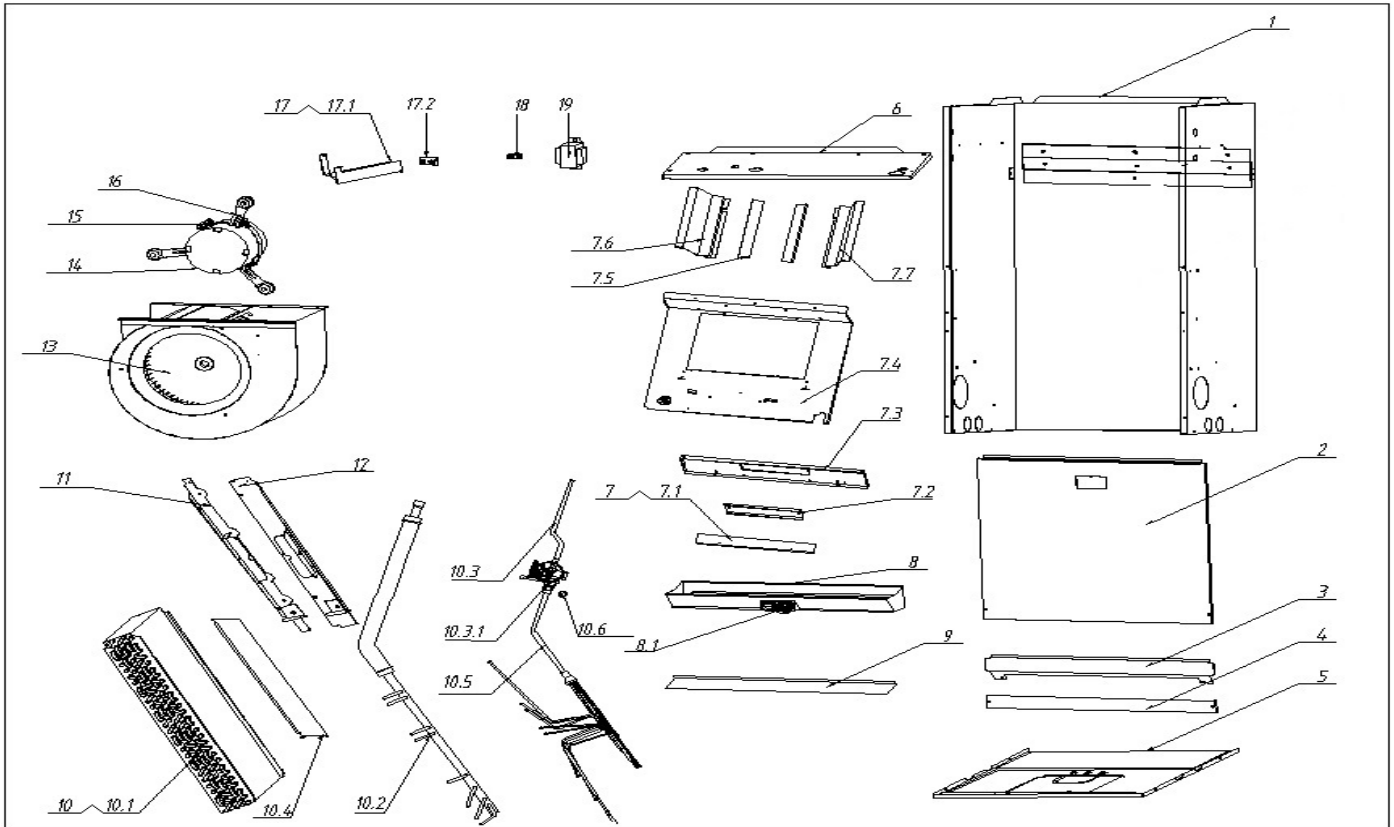

EX_ID	Spare Parts Code	Part Name(EN)	Qty.		
1	12223000002376	Base ass'y	1		
2	12223000010532	Side panel assembly	1		

3	12223000010530	Condenser connection board assembly	1		
4	12223000002182	In the interconnect board assembly	1		
5	12223000010528	Side panel assembly	1		
6	12223000002196	Components on the side	1		
7	12223000004067	Air duct ass'y	1		
7.1	12223000002413	Support board	1		
7.2	12223000002111	Clapboard	1		
7.3	12223000002246	Duct under the baffle	1		
7.4	12223000002332	Wind wheel fixed plate	2		
7.5	12223000002006	Side board	2		
7.6	12223000002239	Left board	1		
7.7	12223000002242	Right board	1		
8	12123000001081	Drainage pan assembly	1		
8.1	15500402000023	seal plug	1		
9	12223000002113	Drainage pan supporting board	1		
10	15823000004353	Evaporator assembly	1		
10.1	15823000004349	Evaporator	1		
10.2	15223000000128	Evaporator output pipe assembly	1		
10.3	15423000004445	Expansion valve ass'y	1		
10.3.1	15500213000075	Thermal expansion valve	1		
10.4	12223000005758	Evaporator windshield plate ass'y	1		
10.5	15223000000129	Distributary ass'y	1		
10.6	12100901000010	Sealing ring	1		
11	12223000010531	Condenser connection board assembly	1		
12	12223000010534	Condenser connection board assembly	1		
13	12200102000003	centrifuge fan	1		
14	11002015000783	Brushless DC Motor	1		
15	12223000001992	Supporter of fan motor	1		
16	12223000001932	Supporter subassembly of fan motor	3		
17	17223000005343	E-part box ass'y	1		
17.1	12223000002174	Electrical Installation plate	1		
17.2	17400401000208	terminal block,2P	1		
18	11201708000008	Wiring Terminal	1		
19	11203103000194	Linear Transformer	1		