

Before using your air conditioner, please read this manual carefully and keep it for future reference.

## INVERTER SPLIT-TYPE ROOM AIR CONDITIONER

# ComfortStar®

# USER'S MANUAL

The design and specifications are subject to change without prior notice for product improvement. Consult with the sales agency or manufacturer for details.

20170630

### Read This Manual

Keep this manual where the operator can easily find them. Inside you will find many helpful hints on how to use and maintain your air conditioner properly. Just a little preventative care on your part can save you a great deal of time and money over the life of your air conditioner. You'll find many answers to common problems in the chart of troubleshooting tips. If you review the chart of Troubleshooting Tips first, you may not need to call for service.

## **CONTENTS**

### **SAFETY PRECAUTIONS**

Warning .....	3
Caution .....	4

### **NAMES OF PARTS**

Indoor unit .....	5
outdoor unit .....	5
Indication lamp.....	5

### **OPERATING INSTRUCTIONS**

Special functions .....	6
Operating temperature.....	7
Manual operation .....	7
Airflow direction control .....	8
How the air conditioner works .....	9

### **CARE AND MAINTENANCE**

Before maintenance.....	10
Cleaning the unit.....	10
Cleaning the air filter and air freshening filter .....	10
Replacement of the air filter and air freshening filter .....	11
Preparation for extended non-operation.....	11
Pre-season inspection.....	11

### **TROUBLESHOOTING TIPS**

Normal function of the air conditioner.....	12
Troubleshooting guide .....	14

**When using this air conditioner in the European countries, please read the following information:**

- This appliance can be used by children aged from 8 years and above and persons with reduced physical, sensory or mental capabilities, or lack of experience and knowledge if they have been given supervision or instruction concerning use of the appliance in a safe way and understand the hazards involved. Children shall not play with the appliance. Cleaning and user maintenance shall not be made by children without supervision.

**DISPOSAL:** Do not dispose of this product as unsorted municipal waste. Collection of such waste separately for special treatment is necessary.

It is prohibited to dispose of this appliance in domestic household waste. For disposal, there are several possibilities:

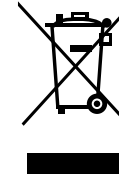

- A) The municipality has established collection systems, where electronic waste can be disposed of at least free of charge to the user.
- B) When buying a new product, the retailer will take back the old product at least free of charge.
- C) The manufacturer will take back the old appliance for disposal at least free of charge to the user.
- D) As old products contain valuable resources, they can be sold to scrap metal dealers.

Wild disposal of waste in forests and landscapes endangers your health when hazardous substances leak into the ground-water and find their way into the food chain.





## SAFETY PRECAUTIONS

To prevent injury to the user or other people and property damage, the following instructions must be followed. Incorrect operation due to ignoring of instructions may cause harm or damage. The seriousness is classified by the following indications.

 <b>WARNING</b>	This symbol indicates the possibility of death or serious injury.
 <b>CAUTION</b>	This symbol indicates the possibility of injury or damage to property.

■ Meanings of symbols used in this manual are as shown below.

	<b>Strictly prohibited.</b>
	<b>Be sure to follow the instructions.</b>

### WARNING



- Do not extend the cable and never use multiple plugs. A poor electrical connection, poor insulation or voltage which is higher than permitted can cause fire.
- Do not expose your body directly to the cool air for prolonged period.
- Never poke fingers, sticks or other objects in the air inlet and outlet vents.
- Never attempt to repair, relocate, modify the air conditioner yourself. Always contact your service partner if it requires.
- Never pull the plug out by pulling on the cable. Hold the plug firmly and pull it out of the plug socket, otherwise there is a risk of damaging the cable.
- Do not operate your air conditioner in a wet room such as a bathroom or laundry room.



- Remove all dirt from the power plug and plug it firmly. Soiled plugs can cause fire or an electric shock.
- In the event of any abnormalities such as smell of burning, immediately switch off the device and pull the plug. Contact your service partner.
- Always switch off the device and pull the plug before you start to clean it.
- Use specified power cord.
- Contact the authorized installer for installation of this unit.
- Contact an authorized service technician for repair or maintenance of this unit.
- This appliance is not intended for use by persons (including children) with reduced physical, sensory or mental capabilities, or lack of experience and knowledge, unless they have been given supervision or instruction concerning use of the appliance by a person responsible for their safety.
- Children should be supervised to ensure that they do not play with the air conditioner.

## SAFETY PRECAUTIONS

### CAUTION



- Never actuate any switches with a wet hand. It may cause an electric shock.
- Never use the device for any other purpose than the intended use. Never place food, precision instruments, plants, animals, paint, etc. on the unit.
- Do not expose plants or animals directly to the air flow.
- Never clean the air conditioner with water. Never use combustible cleaning agents as these could cause a fire or deformation.
- Never place any burning objects close to the device if they could be directly affected by the emitted air.
- Never step onto the outdoor device and never place anything on it. Never use an unsteady or rusty base.
- Never install the air conditioner in places where combustible gas can be emitted. Emitted gas may collect and cause an explosion.
- Never allow the air conditioner to run for too long with the doors or windows open, or if the humidity is very high.



- If the air conditioner is to be used in conjunction with other heaters, the air should be refreshed periodically, otherwise there is a risk of lack of oxygen.
- Always pull out the power plug if the unit is not going to be used for any lengthy period of time. Collections of dust can cause fire.
- Always switch off the air conditioner and pull out the power plug during a storm. Electrical parts may get damaged.
- Check that the drainage line is correctly connected. If not, water will escape.
- Check that the condensation water can run off unhindered. It may cause water damage if the condensation water cannot run off properly.
- The air conditioner must be earthed in accordance with the local codes.
- For electrical safety purposes we recommend that you install an earth-leakage circuit-breaker.
- If the power cord is damaged, it must be replaced by the manufacturer, its service agent or similarly qualified persons in order to avoid a hazard.

## NAMES OF PARTS

### Indoor unit

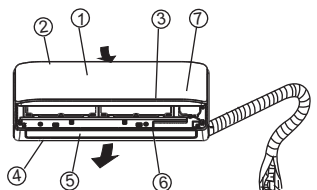

### Outdoor unit

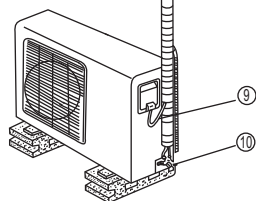

### Indication lamp

NOTE: The display window of the air conditioner you purchased may be slightly different from front panel and display window. The actual shape shall prevail.

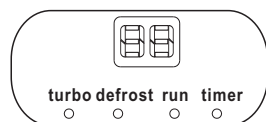

(1)

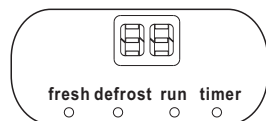

(2)

### Names of parts

#### Indoor unit

1. Front panel
2. Air inlet
3. Air filter
4. Air outlet
5. Horizontal air flow grille
6. Vertical air flow louver(inside)
7. Display panel

#### Outdoor unit

8. Connecting pipe
9. Connecting cable
10. Stop valve

#### NOTE:

All the pictures in this manual are for explanation purposes only. The actual shape of the indoor unit you purchased may be slightly different from front panel and display window. The actual shape shall prevail.

#### Indication lamp

##### **TURBO indication lamp**(optional function)

This lamp illuminates when TURBO feature is activated.

##### **FRESH indication lamp**(optional function)

This lamp illuminates when Clean Air feature is activated.

##### **DEFROST indication lamp**

(Applicable to cooling & heating models only): Lights up when the air conditioner starts defrosting automatically or when the warm air control feature is activated in heating operation.

##### **RUN indication lamp**

This lamp illuminates when the air conditioner is in operation.

##### **TIMER indication lamp**

Lights up during Timer operation.



##### **Temperature indicator**

- Displays the temperature settings when the air conditioner is operational.
- Displays the malfunction code.

## OPERATING INSTRUCTIONS

### Special functions

#### Refrigerant Leakage Detection

With this new technology, the display area will appear 'EC' or the LED indication lamps keep flashing (depending on models) when the outdoor unit detects refrigerant leakage.

#### Louver Angle Memory Function(optional):

Within the scope of safety angle, it will memorize the open angle of horizontal louver. If it exceeds, it will memorize the boundary of safety angle. In the following circumstances, it will return to standard angle: 1) pressing the manual switch, 2)unplug and then plug in the machine. So we strongly suggest that the open angle of the horizontal louver should not be set too small, in case the condensed water forms and drops from the horizontal louver.

#### SELF CLEAN function(optional):

- Function used after the Shut Down of cooling operation to clean the Evaporator and keep it as fresh for the next operation.
- The unit will operate as following sequence : FAN ONLY mode at Low fan speed--Heating operation with LOW fan speed(applicable to cooling & heating models only) ---FAN ONLY operation--Stop Operation---Turn off.

#### Note:

- This function is only available under COOL(AUTO COOL, FORCED COOL) and DRY mode. Before select the function, it is recommended to run the air conditioner under Cooling operation for about half an hour.
- Once the Self Clean function is activated, all TIMER setting will be cancelled.
- During Self Clean operation, when press the SELF CLEAN button on the remote controller again will stop the operation and turn off the unit automatically.

#### TURBO function(optional):

Turbo function enables the unit to reach the preset temperature in the shortest time. When press this button on cooling mode, the unit will blow strong cooling air with super high fan speed. When press this button on heating mode (applicable to the unit adopts Electric heater only), the Electric heater will be energized and bring fast heating operation.

#### CLEAN AIR function(optional):

This air conditioner is equipped with ionizer or Plasma Dust Collector(Depending on specific configuration of the model). With the anions generated by Ionizer, the air circulation of the air conditioner fills the room with refreshing, natural and healthy air. The Plasma Dust Collector generates a high voltage ionization zone, through which the air is converted to plasma. Inside the air most of the dust, smoke, and pollen particles are captured by the electrostatic filter.

#### Anti-mildew function(optional):

- When turns off the unit on COOL, DRY, AUTO (Cool) mode, the air conditioner will continue operating for about 7-10 minutes (depending on models) at LOW fan speed. If turns off on HEAT mode, the unit will continue operating for about 30 seconds at LOW fan speed. This will help to dry up the condensed water inside the evaporator, and prevent the breeding of mildew.
- Under Anti-mildew operation, do not restart the air conditioner until the unit is completely off.

#### Vertical swing function(optional):

After the AC starts up, users can control the vertical louver swing by the remote controller.

## OPERATING INSTRUCTIONS

**NOTE:** This manual does not include Remote Controller Operations, see the <<Remote Controller Instruction>> packed with the unit for details.

### Operating temperature

Mode	Cooling operation	Heating operation	Drying operation
Room temperature	17°C~32°C (62°F~90°F)	0°C~30°C (32°F~86°F)	10°C~32°C (50°F~90°F)
Outdoor temperature	0°C~50°C (32°F~122°F)  (-15°C~50°C/5°F~122°F: For the models with low temperature cooling system)	-15°C~30°C (5°F~86°F)	0°C~50°C (32°F~122°F)

### NOTE:

- Optimum performance will be achieved within these operating temperatures. If air conditioner is used outside of the above conditions, certain safety protection features might come into operation and cause the unit to function abnormally.
- If the air conditioner runs for a long time in cooling mode and the humidity is high (over 80%), condensed water may drip out of the unit. Please set the vertical air flow louver to its maximum angle (vertically to the floor), and set HIGH fan mode.

**Suggestion:** For the unit adopts an Electric Heater, when the outside ambient temperature is below 0°C(32°F), we strongly recommend you to keep the machine plugged in order to guarantee it running smoothly.

### Manual operation

Units are equipped with a switch to run emergency operation mode. It can be accessed by opening the front panel. This switch is used for manual operation in case the remote controller fails to work or maintenance necessary.

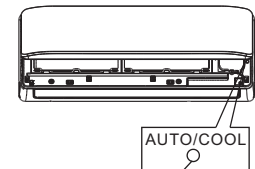

(1)

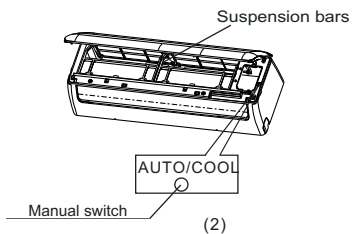

(2)

**NOTE:** The unit must be turned off before operating the manual control button. If the unit is operational, continue pressing the manual control button until the unit is off.

- Open and lift the front panel up to an angle until it remains fixed with a clicking sound. For some models, please use suspension bars to prop up the panel.
- One press of the manual control switch will lead to the forced AUTO operation. If press the switch twice within five seconds, the unit will operate under forced COOL operation.
- Close the panel firmly to its original position.

### CAUTION:

- This switch is used for testing purposes only. You had better not choose it.
- To restore the remote controller operation, use the remote controller directly.

7

## OPERATING INSTRUCTIONS

### Airflow direction control

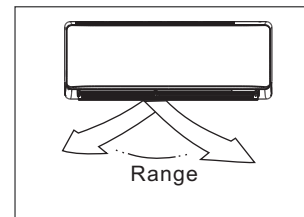
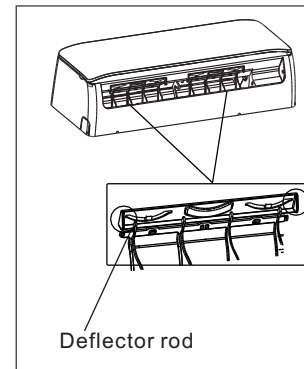
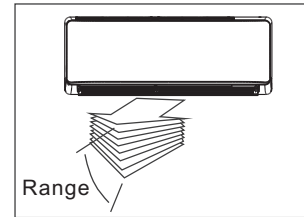

Adjust the air flow direction properly otherwise it might cause discomfort or cause uneven room temperatures.

Adjust the horizontal/vertical louver using the remote controller. For some models, the vertical louver can only be adjusted manually.

### To set the horizontal/vertical air flow direction

- Perform this function while the unit is in operation.
- Use the remote controller to adjust the air flow direction. The vertical/horizontal louver changes 6 degree in angle for each press, or swing up and down automatically. Please refer to the 'REMOTE CONTROLLER OPERATION MANUAL' for details.
- For some models, the vertical louver can only be adjusted manually. Move the deflector rod manually to adjust the air flow in the direction you prefer.

**IMPORTANT:** Do not put your fingers into the panel of blower and suction side. The high-speed fan inside may cause danger.

### CAUTION

- Do not operate the air conditioner for long periods with the air flow direction set downward in cooling or dehumidifying mode. Otherwise, condensation may occur on the surface of the horizontal louver causing moisture to drop on to the floor or on furnishings.
- When the air conditioner is started immediately after it was stopped, the horizontal louver might not move for approximately 10 seconds.
- Open angle of the horizontal louver should not be set too small, as COOLING or HEATING performance may be impaired due to too restricted air flow area.
- Do not move the horizontal louver manually, otherwise the horizontal louver will be out of sync. Please cease operating, unplug power for a few seconds, then restart the air conditioner.
- Do not operate unit with horizontal louver in closed position.

8

### How the air conditioner works

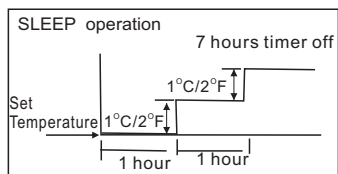

#### Cooling

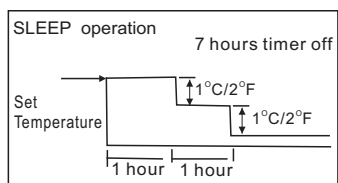

#### Heating

#### AUTO operation

- When you set the air conditioner in AUTO mode, it will automatically select cooling, heating (cooling/heating models only), or fan only operation depending on set temperature and the room temperature.
- The air conditioner will control room temperature automatically to the temperature point you set.
- If you feel uncomfortable in the AUTO mode, you can set your desired temperature.

#### SLEEP operation

When you push SLEEP button on remote controller during cooling, heating (cooling & heating models only), or AUTO operation, the air conditioner will automatically increase (cooling) or decrease (heating) 1°C/2°F per hour for the first 2 hours, then hold steadily for the next 5 hours, after that it will switch off. This mode saves you energy and brings you comfort at night.

#### DRYING operation

- The fan speed will be automatically controlled under dry operation.
- During the dry operation, if the room temperature is lower than 10°C (50°F), the compressor stops operation and restarts until the room temperature is above 12°C (54°F).

#### Optimal operation

- To achieve optimal performance, please note the following:
  - Adjust the air flow direction correctly so that it is not towards people.
  - Adjust the temperature to achieve the highest comfort level. Do not adjust the unit to excessive temperature levels.
  - Close doors and windows on COOL or HEAT modes, or performance may be reduced.
  - Use TIMER ON button on the remote controller to select a time you want to start your air conditioner.
  - Do not put any object near air inlet or air outlet, as the efficiency of the air conditioner may be reduced and the air conditioner may stop running.
  - Clean the air filter periodically, otherwise cooling or heating performance may be reduced.
- Do not operate unit with horizontal louvre in closed position.

### Care and Maintenance

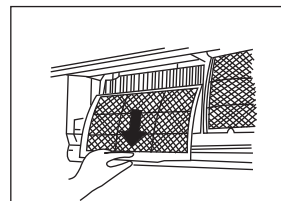
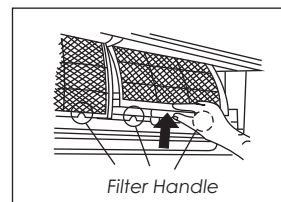
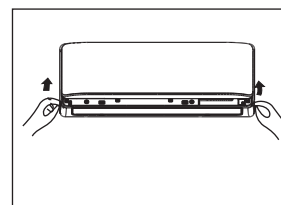

#### Before maintenance

- Turn the system off before cleaning. To clean, wipe with a soft, dry cloth. Do not use bleach or abrasives.

**NOTE:** Power supply must be disconnected before cleaning the indoor unit.

#### CAUTIONS

- A cloth dampened with cold water may be used on the indoor unit if it is very dirty. Then wipe it with a dry cloth.
- Do not use a chemically treated cloth or duster to clean the unit.
- Do not use benzene, thinner, polishing powder, or similar solvents for cleaning. These may cause the plastic surface to crack or deform.
- Never use water hotter than 40°C/104°F to clean the front panel, it could cause deformation of discolouration.

#### Cleaning the unit

wipe the unit with a soft dry cloth only. If the unit is very dirty, wipe it with a cloth soaked in warm water.

#### Cleaning the air filter and air freshening filter

A clogged air filter reduces the cooling efficiency of this unit. Please clean the filter once every 2 weeks.

1. Lift the indoor unit panel up to an angle until it stops with a clicking sound. For some models, please use suspension bars to prop up the panel.
2. Take hold of the handle of the air filter and lift it up slightly to take it out from the filter holder, then pull it downwards.
3. Remove the AIR FILTER from the indoor unit. Clean the AIR FILTER once two weeks. Clean the AIR FILTER with a vacuum cleaner or water, then dry it up in cool place.

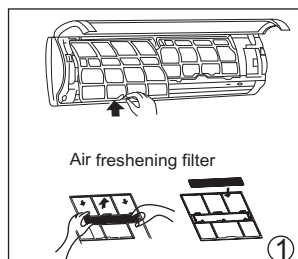

Air freshening filter

4. Remove the Air Freshening Filters from its supporting frame (The solution to disassemble may differ from each other for different filters. Refer to ① and ② ). Clean the air freshening filter at least once a month, and replace it every 4-5 months.  
Clean it with vacuum cleaner, then dry it in cool place.
- ⚠ For the models with plasma, do not touch the plasma within 10 minutes after you open the panel.
5. Install the air freshening filter back into position.
6. Insert the upper portion of air filter back into the unit, taking care that the left and right edges line up correctly and place filter into position.

**Replacement of air filter and air freshening filter**

1. Remove the air filter.
2. Remove the air freshening filter.
3. Install a new air freshening filter.
4. Reinstall the air filter and securely close the front panel.

**Preparation for extended non-operation**

If you plan to idle the unit for a long time, perform the following:

- (1) Clean the indoor unit and filters.
- (2) Operate the fan for about half a day to dry the inside of the unit.
- (3) Stop the air conditioner and disconnect power.
- (4) Remove the batteries from the remote controller.  
The outdoor unit requires periodic maintenance and cleaning. Do not attempt to do this yourself. Contact your dealer or service provider.

**Pre-season inspection**

- Check that the wiring is not broken off or disconnected.
- Clean the indoor unit and filters.
- Check that the air filter is installed.
- Check if the air outlet or inlet is blocked after the air conditioner has not been used for a long time.

**⚠ Caution**

- Do not touch the metal parts of the unit when removing the filter. Injuries can occur when handling sharp metal edges.
- Do not use water to clean inside the air conditioner. Exposure to water can destroy the insulation, leading to possible electric shock.
- When cleaning the unit, first make sure that the power and circuit breaker are turned off.
- Do not wash air filter with hot water at more than 40°C/104 F. Shake off moisture completely and dry it in the shade. Do not expose it directly to the sun, it may shrink.

**Normal function of the air conditioner**

The following events may occur during normal operation.

**1. Protection of the air conditioner.**

**Compressor protection**

- The compressor can't restart for 3-4 minutes after it stops.
- Anti-cold air (Cooling and heating models only)**
- The unit is designed not to blow cold air on HEAT mode, when the indoor heat exchanger is in one of the following three situations and the set temperature has not been reached.
  - A) When heating has just started.
  - B) Defrosting.
  - C) Low temperature heating.
- The indoor or outdoor fan stop running when defrosting (Cooling and heating models only).

**Defrosting (Cooling and heating models only)**

- Frost may be generated on the outdoor unit during heat cycle when outdoor temperature is low and humidity is high resulting in lower heating efficiency of the air conditioner.
- During this condition air conditioner will stop heating operation and start defrosting automatically.
- The time to defrost may vary from 4 to 10 minutes according to the outdoor temperature and the amount of frost built up on the outdoor unit.

**2. A white mist coming out from the indoor unit**

- A white mist may generate due to a large temperature difference between air inlet and air outlet on COOL mode in an indoor environment that has a high relative humidity.
- A white mist may generate due to moisture generated from defrosting process when the air conditioner restarts in HEAT mode operation after defrosting.

**3. Low noise of the air conditioner**

- You may hear a low hissing sound when the compressor is running or has just stopped running. It is the sound of the refrigerant flowing or coming to a stop.
- You can also hear a low "squeak" sound when the compressor is running or has just stopped running. This is caused by heat expansion and cold contraction of the plastic parts in the unit when the temperature is changing.
- A noise may be heard due to louver restoring to its original position when power is turned on.

**4. Dust is blown out from the indoor unit.**

This is a normal condition when the air conditioner has not been used for a long time or during first use of the unit.

**5. A peculiar smell comes out from the indoor unit.**

This is caused by the indoor unit giving off smells permeated from building material, from furniture, or smoke.

**6. The air conditioner turns to FAN only mode from COOL or HEAT (For cooling and heating models only) mode.**

When indoor temperature reaches the temperature setting on air conditioner, the compressor will stop automatically, and the air conditioner turns to FAN only mode. The compressor will start again when the indoor temperature rises on COOL mode or falls on HEAT mode (For cooling and heating models only) to the set point.

## TROUBLESHOOTING TIPS

### 7. The air conditioner runs Anti-mildew function after turning off the unit.

When turning off the unit under COOL(AUTO COOL, FORCED COOL) and DRY mode, the air conditioner will run Anti-mildew function for 7-10 minutes, if turns off on HEAT mode, the unit will continue operating for about 30 seconds at LOW fan speed, then stop the operation and turn off the unit automatically.

8. Dripping water may generate on the surface of the indoor unit when cooling in a high relatively humidity (relative humidity higher than 80%). Adjust the horizontal louver to the maximum air outlet position and select HIGH fan speed.

### 9. Heating mode (For cooling and heating models only)

The air conditioner draws in heat from the outdoor unit and releases it via the indoor unit during heating operation. When the outdoor temperature falls, heat drawn in by the air conditioner decreases accordingly. At the same time, heat loading of the air conditioner increases due to larger difference between indoor and outdoor temperature. If a comfortable temperature can't be achieved by the air conditioner, we suggest you use a supplementary heating device.

### 10. Auto-restart function

- Power failure during operation will stop the unit completely.
- For the unit without Auto-restart feature, when the power restores, the OPERATION indicator on the indoor unit starts flashing. To restart the operation, push the ON/OFF button on the remote controller. For the unit with Auto-restart feature, when the power restores, the unit restarts automatically with all the previous settings preserved by the memory function.

## TROUBLESHOOTING TIPS

### Troubleshooting guide

If one of the following faults occurs, stop the air conditioner immediately, disconnect the power and then connect it in again. If the problem still exists, disconnect the power and contact the nearest customer service center.	
<b>Trouble</b>	OPERATION indicator or other indicators continue flashing.
	Fuse blows frequently or circuit breaker trips frequently.
	Other objects or water fall into the air conditioner.
	The remote controller won't work or works abnormally.
If one of the following code appears on the display area : E0,E1,E2,E3.....or P0,P1,P2,P3.....	

Malfunctions	Cause	What should be done?
<b>Unit does not start</b>	Power cut	Wait for power to be restored.
	Unit may have become Unplugged.	Check that plug is securely in wall receptacle.
	Fuse may have blown.	Replace the fuse.
	Battery in Remote controller may have been exhausted.	Replace the battery.
	The time you have set with timer is incorrect.	Wait or cancel timer setting.
<b>Unit not cooling or heating (Cooling/ heating models only) room very well while air flowing out from the air conditioner</b>	Inappropriate temperature setting.	Set temperature correctly. For detailed method please refer to "Using remote control" section.
	Air filter is blocked.	Clean the air filter.
	Doors or Windows are open.	Close the doors or windows.
	Air inlet or outlet of indoor or outdoor unit has been blocked.	Clear obstructions away first, then restart the unit.
	Compressor 3 minutes protection has been activated.	Wait.
If the trouble has not been corrected, please contact a local dealer or the nearest customer service center. Be sure to inform them of the detailed malfunctions and unit model number.		

**Notes: Do not attempt to repair the unit yourself.**

**Always consult an authorized service provider.**