

Exploded View

Model CZP60CD(O)

ComfortStar®

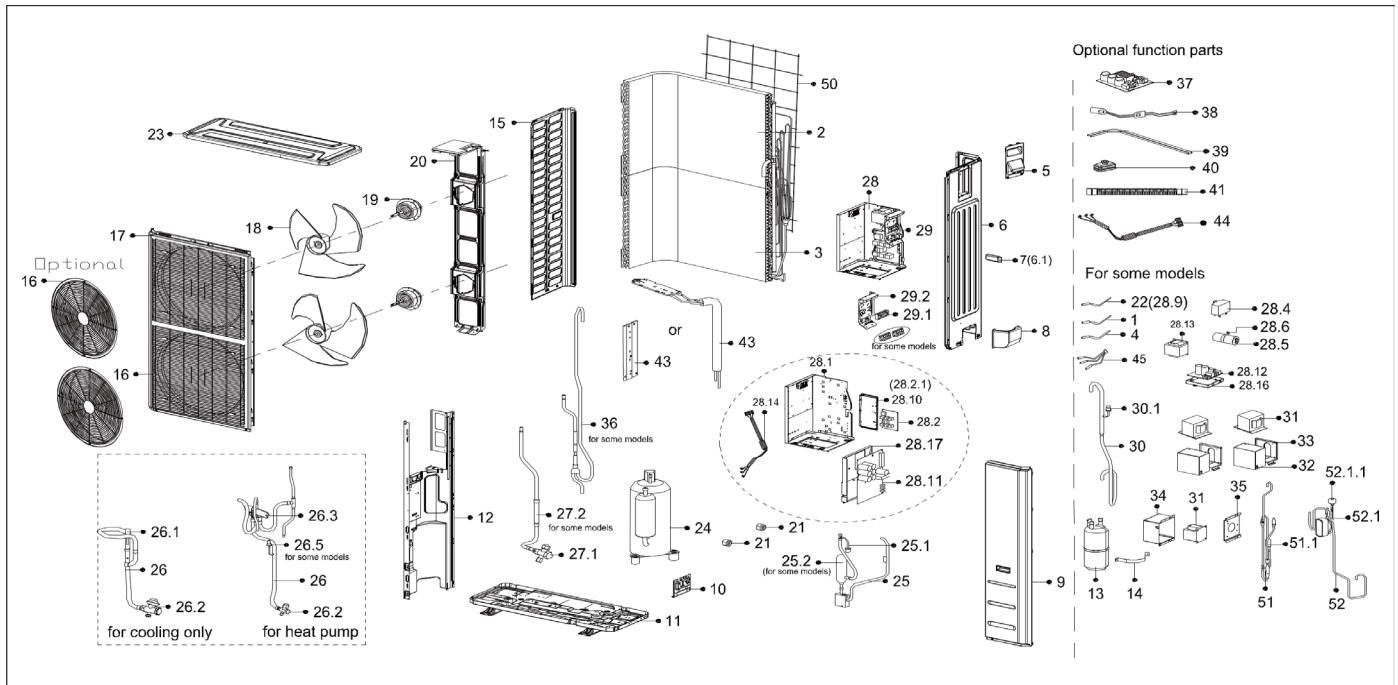

EX_ID	Spare Parts Code	Part Name(EN)	Qty.	Price	Remarks
1	11201007003448	Room Temperature Sensor	1		
2	15822000008311	Condenser Assembly1	1		
3	15822000008313	Condenser Assembly2	1		
4	11201007003441	Pipe Temperature Sensor	1		
5	12222000013365	Big handle assembly	1		
6	12222000012373	Rear right clapboard assembly	1		
6.1	12100702000038	handle	1		
8	12122000014023	Water collector	1		
9	12222000006287	Front right clapboard assembly	1		

10	12222200002361	Valve plate	1		
11	12222000006290	Chassis assembly	1		
12	12222000005733	Partition board assembly	1		
13	15500508000009	Liquid-storage tank	1		
15	12222200002363	Left side plate assembly of cabinet	1		
16	12222000014845	Air outlet grille	2		
17	12222000007564	Front panel	1		
18	12100105000022	Axial flow fan	2		
19	11002015009825	Brushless DC Motor	2		
20	12222000006288	Supporter subassembly of fan motor	1		
21	15500406000008	Copper nut1	1		
21	15500406000010	Copper nut2	1		
22	11201007003124	Discharge Temperature Sensor	1		
23	12222200002359	Top cover assembly	1		
24	11103020002859	DC Inverter Rotary Compressor	1		
25	15122000027660	Discharge pipe assembly	1		
25.1	17400516000851	Pressure switch1	1		
26	15422000018875	4-way valve assembly	1		
26.2	15500204000482	Gas valve	1		
26.3	15500216000681	4-way valve	1		
27	15422000019513	Liquid valve assembly	1		
27.1	15500208000286	Liquid valve	1		
27.2	15500210001488	Throttle valve	1		
28	17222000037674	Electronic control box subassembly	1		
28.1	12222000012372	Installation plate of electric parts subassembly	1		
28.2	17122000055348	Inverter module subassembly	1		
28.10	12122000014342	Electronic installing box1	1		
28.11	17122000055690	Outdoor main control board subassembly	1		
28.14	17401203000936	Compressor wire subassembly	1		
28.17	12122000020943	Electronic installing box2	1		
29	17222000031405	Terminal board subassembly	1		
29.1	17400401003456	Wire joint1	1		
29.1	17400401000098	Terminal	1		
29.1	17400401000085	Wire joint2	1		

29.2	12222000012265	Terminal instalation subassembly	1		
30	15122000026165	Suction pipe assembly	1		
30.1	17400516000008	Pressure switch2	1		
38	17402001000602	Crankcase electric heating strip	1		
39	17402002000466	Electric heating tube	1		
43	15122000024994	Radiator subassembly	1		
50	12222000007944	Rear net	1		
51	15422000019492	Electronic expansion valve subassembly	1		
51.1	15500213000245	Electronic expansion valve	1		