

Exploded View

Model

CZP09CD(O)

ComfortStar®

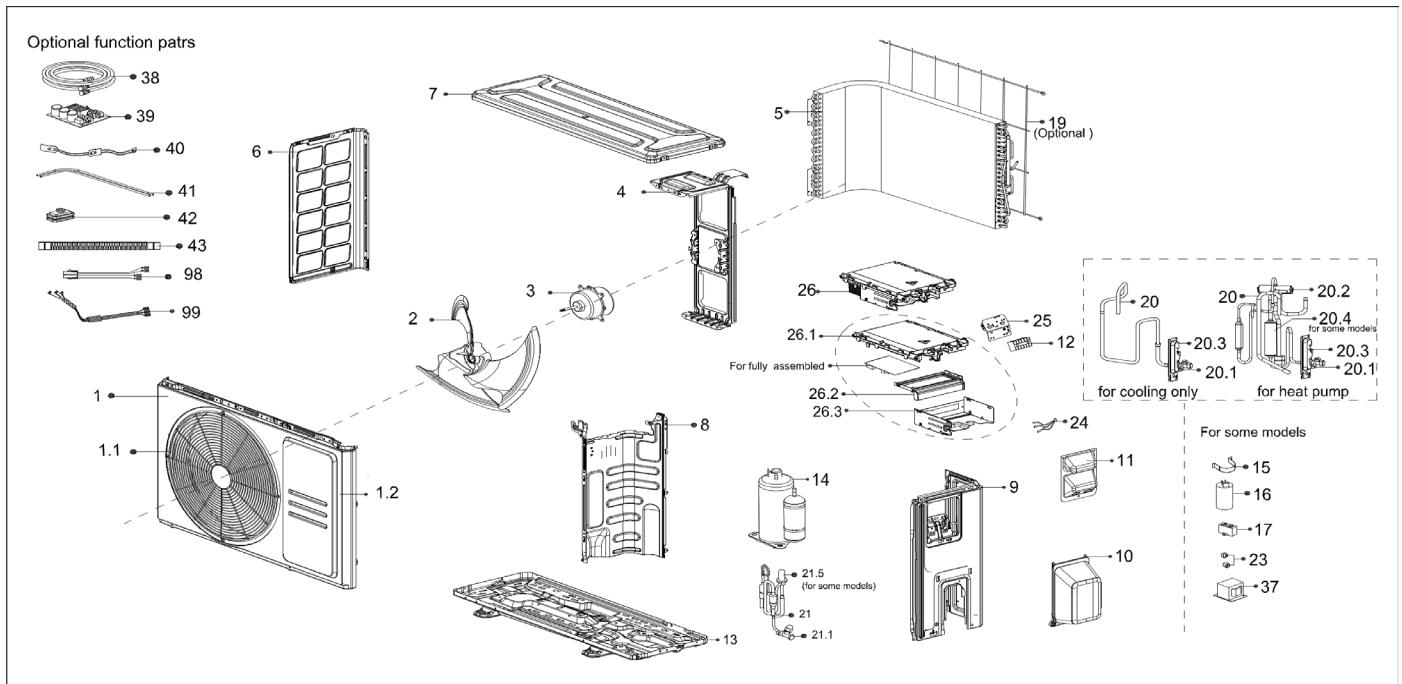

EX_ID	Spare Parts Code	Part Name(EN)	Qty.	Price	Remarks
1	12222000A06317	Front panel assembly	1		
1.1	12222000A06318	Front panel	1		
1.2	12222000A06318	Front panel1	1		
2	12100105000961	Axial flow fan	1		
3	11002015012128	Brushless DC Motor	1		
4	12222000013233	Supporter of fan motor	1		
5	15822000010742	Condenser assembly	1		
6	12222000013238	Left supporter	1		
7	12222000013240	Top cover assembly	1		

8	12222000013665	Partition board assembly	1		
9	12222000013225	Right clapboard assembly	1		
10	12122000007150	Water collector	1		
11	12222000010966	Big handle assembly	1		
12	17400401000068	Terminal	1		
13	12222000013431	Chassis assembly	1		
14	11103020005082	DC Inverter rotary compressor	1		
19	12222000015606	Rear net	1		
20	15422000017913	4-way Valve Assembly	1		
20.1	15500204000021	Gas valve	1		
20.2	15500216001903	4-way valve	1		
20.3	12222200005738	Valve plate	1		
20.4	15122000026302	Muffler Subassembly	1		
21	15422000018014	Liquid valve assembly	1		
21.1	15500208000028	Liquid valve	1		
21.5	15500213000047	Electronic expansion valve subassembly	1		
23	15500406000010	Copper nut	1		
23	15500406000016	Copper nut1	1		
24	11201011000067	Combination sensor	1		
25	12222000002259	Terminal board	1		
26	17222000037700	Electronic control box subassembly	1		
26.1	12122000024223	Support of electronic control box	1		
26.2	12122000024222	Fixing board	1		
26.3	12222000012106	Electronic installing box subassembly	1		
40	17402001000600	Crankcase electric heating strip	1		
41	17402002000464	Electric heating tube	1		
99	17401203012697	Compressor wire subassembly	1		