

Exploded View

Model CHF12CA(I)

ComfortStar®

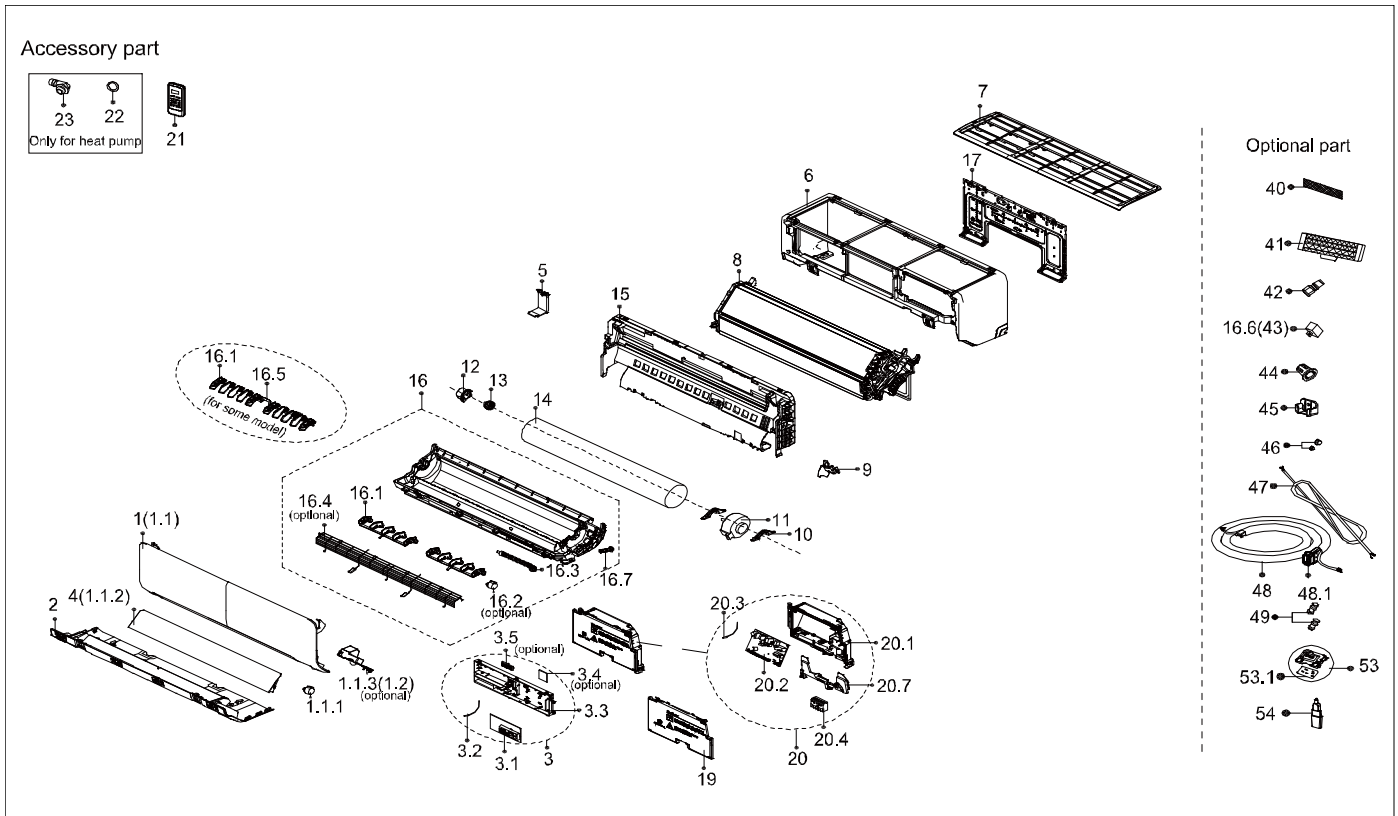

EX_ID	Spare Parts Code	Part Name(EN)	Qty.	Price	Remarks
1	12122000026983	Panel assembly	1.0		
1.1	12122000026984	Panel assembly	1.0		
1.1.1	11002010000326	Stepper motor	1.0		
1.1.2	12122000027051	Horizontal louver	1.0		
2	12122000026607	Panel assembly	1.0		
3	17222000032604	Display box assembly	1.0		
3.1	17122000050213	Display board assembly	1.0		
3.2	11201007003103	Ambient temperature sensor subassembly	1.0		
3.3	12122000026921	Display box	1.0		

5	12122000026621	Chassis supporter	1.0		
6	12122000026423	Panel frame assembly	1.0		
7	12122000026428	Air filter	1.0		
8	15822000011142	evaporator assembly	1.0		
9	12122000026609	Pipe clamp board	1.0		
10	12122000011994	Fixing plate for fan motor	2.0		
11	11002015006201	Motor	1.0		
12	12122000000350	bearing holder	1.0		
13	12622000000131	bearing base	1.0		
14	12100102000696	Cross flow fan	1.0		
15	12122000026603	Chassis assemble((above)	1.0		
16	12122000028661	Chassis assemble((below)	1.0		
16.1	12122000026617	louver	4.0		
16.1	12122000026616	louver	6.0		
16.2	11002010001486	Stepper motor	1.0		
16.3	12100501000032	Drain pipe joint	1.0		
16.4	12922000001991	Air outlet Protective wire	1.0		
16.5	12122000026618	Connecting rod of louver	1.0		
16.7	12622000000030	Drainage plug	1.0		
17	12222000013705	Installation plate	1.0		
19	12122000026601	Cover of electronic control box	1.0		
20	17222000033142	Structural components of indoor electric control	1.0		
20.1	12122000026606	Electronic control box	1.0		
20.2	17122000050729	Indoor main control board subassembly	1.0		
20.3	11201007003445	Pipe temperature sensor subassembly	1.0		
20.4	17400401000577	Terminal block	1.0		
20.7	12122000026605	Electric control box bracket	1.0		
21	17317000007564	remote controller	1.0		
22	12600701000039	Sealing ring	1.0		
23	12100509000061	Drain pipe joint	1.0		
40	12100204000685	Air freshening filter	1.0		
42	15500209000001	Detection valve	1.0		
46	15500406000016	Copper nut	1.0		
46	15500406000012	Copper nut	1.0		