

# Exploded View

Model CZP12CD(O)

# ComfortStar®

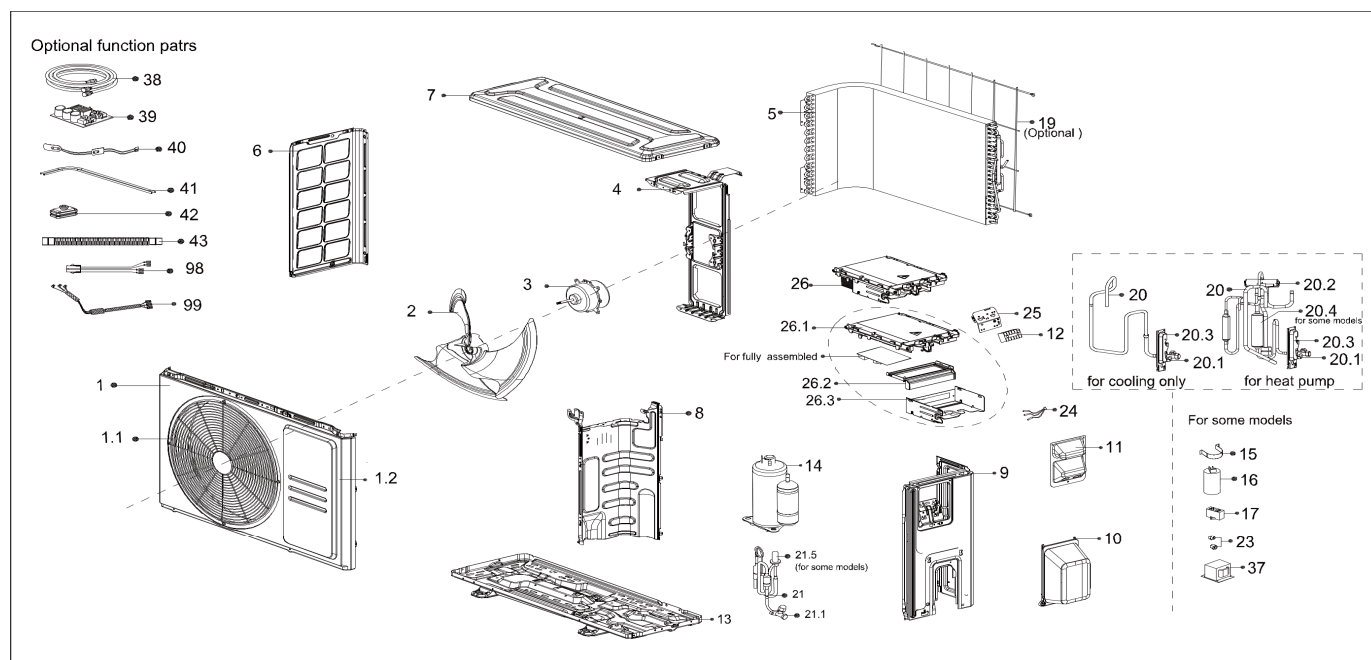

EX_ID	Spare Parts Code	Part Name(EN)	Qty.	Price	Remarks	Update
1	12222000A06317	Front panel assembly	1			
1.1	12222000A06318	Front panel	1			
1.2	12222000A06318	Front panel1	1			
2	12100105000961	Axial flow fan	1			
3	11002015012128	Brushless DC Motor	1			
4	12222000013233	Supporter of fan motor	1			
5	15822000010742	Condenser assembly	1			
6	12222000013238	Left supporter	1			
7	12222000013240	Top cover assembly	1			
8	12222000013665	Partition board assembly	1			
9	12222000013225	Right clapboard assembly	1			
10	12122000007150	Water collector	1			
11	12222000010966	Big handle assembly	1			
12	17400401000068	Terminal	1			
13	12222000013431	Chassis assembly	1			
14	11103020005082	DC Inverter rotary compressor	1			

19	12222000015606	Rear net	1			
20	15422000017979	4-way Valve Assembly	1			
20.1	15500204000058	Gas valve	1			
20.2	15500216001903	4-way valve	1			
20.3	12222200005738	Valve plate	1			
20.4	15122000026590	Muffler subassembly	1			
21	15422000018014	Liquid valve assembly	1			
21.1	15500208000028	Liquid valve	1			
21.5	15500213000047	Electronic expansion valve subassembly	1			
23	15500406000012	Copper nut	1			
23	15500406000016	Copper nut1	1			
24	11201011000067	Combination sensor	1			
25	12222000002259	Terminal board	1			
26	17222000033256	Electronic control box subassembly	1			
26.1	/	Support of electronic control box	1		CSN after*23326xxxx	
	12122000024223				CSN after*23104xxxx	20230630
26.2	12122000024222	Fixing board	1			
26.3	12222000012106	Electronic installing box subassembly	1			
26.5	17122000060453	Outdoor main control board subassembly	1		add.CSN after*23326xxxx	20230614
40	17402001000600	Crankcase electric heating strip	1			
41	17402002000464	Electric heating tube	1			
99	17401203012697	Compressor wire subassembly	1			