

# Exploded View

Model

CHX36CD

**ComfortStar®**

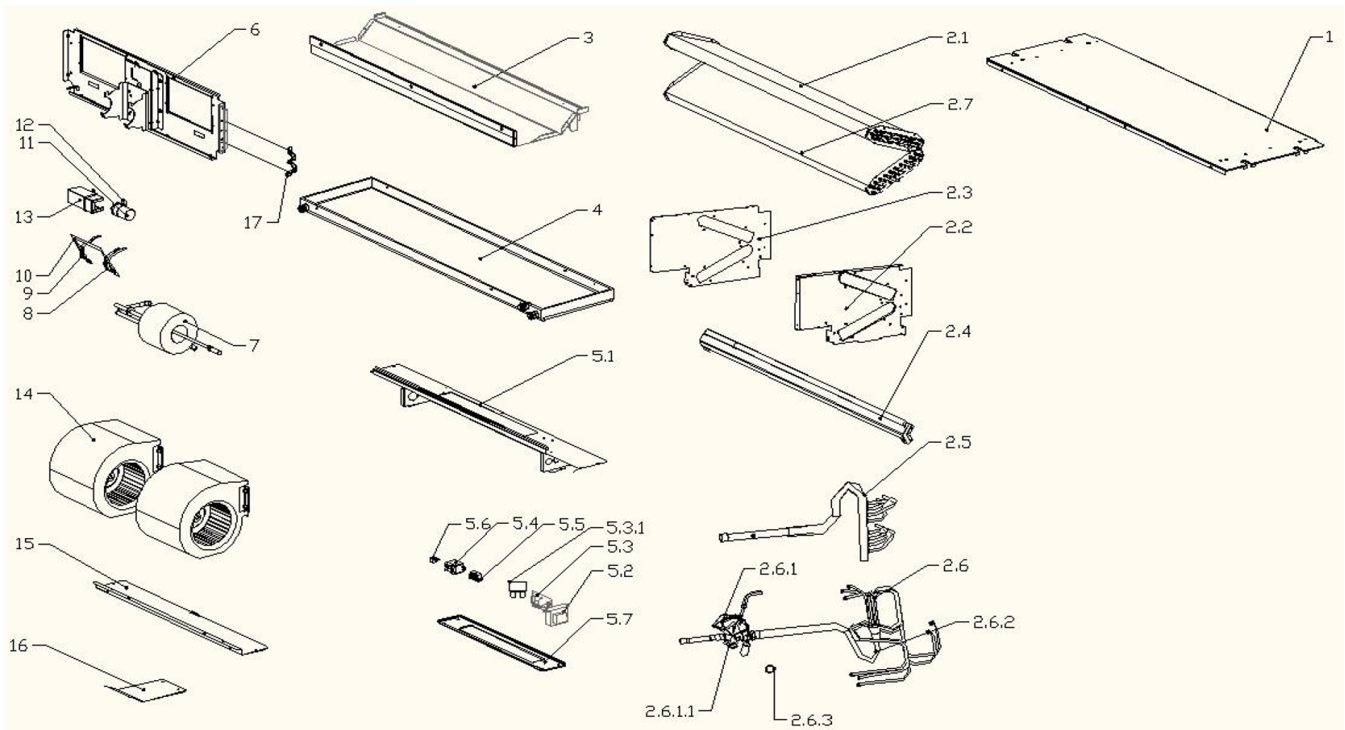
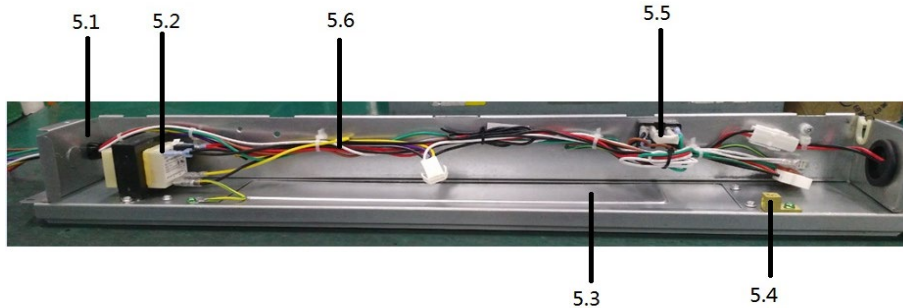

EX_ID	Spare Parts Code	Part Name(EN)	Qty.	Price	Remarks
1	12223000001360	Top cover ass'y	1		
2	15823000004341	Evaporator assembly	1		

2.1	15823000004342	Evaporator	1		
2.2	12223000007091	Sealed board	1		
2.3	12223000010729	Sealing panel assembly	1		
2.4	12223000001769	Connecting plate ass'y	1		
2.5	15223000000145	Evaporator output pipe assembly	1		
2.6	15423000004458	Evaporator input pipe assembly	1		
2.6.1	15423000004459	Expansion valve ass'y	1		
2.6.1.1	15500213000075	Thermal expansion valve	1		
2.6.2	15223000000146	Distributary ass'y	1		
2.6.3	12100901000010	Sealing ring	1		
2.7	15823000004343	Evaporator	1		
3	12223000001701	Drainage deflector ass'y	1		
4	12223000014871	Drainage pan assembly	1		
5	17223000005336	E-box ass'y	1		
5.1	12223000004168	E-box	1		
5.2	11203103000194	Linear Transformer	1		
5.3	12223000001400	Sealing plate	1		
5.4	11201708000008	Wiring Terminal	1		
5.5	17400401000208	terminal block,2P	1		
6	12223000010730	Beam ass'y	1		
7	11002015000521	Brushless DC Motor	1		
8	12222500000253	Fan Motor Axes Clamp (Left)	1		
9	12222500000255	Fan Motor Axes Clamp (Right)	1		
10	12226000000365	Board	1		
12	12223000001397	Cover, E-box	1		
13	12223000001376	Cover, motor	1		
14	12223000001624	Pipe clamp board	1		