



Submittal

Split System Cooling

BAH4-24-15

Location: _____
Engineer: _____
Submitted to: _____
Submitted by: _____
Reference: _____

Approval: _____
Date: _____
Construction: _____
Unit # : _____
Drawing # : _____



Note: "Graphics in this document are for representation only. Actual model may differ in appearance."

Unit dimension

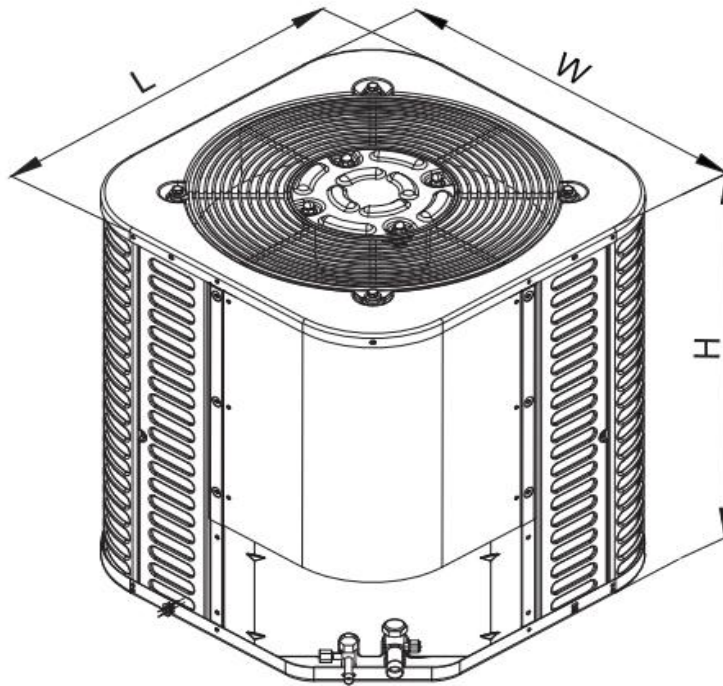

Unit size	
Model	H x W x L (inches)
18K/24K(AC)	25 x 21-4/5 x 21-4/5
24K(HP)/ 30K/36K	25 x 29-1/7 x 29-1/7
42K/48K/60K	32-7/8 x 29-1/7 x 29-1/7

Specification

Model			BAH4-24-15
Outdoor power supply		V/Ph/Hz	230V/1N/60HZ
Max. input consumption		W	2400.00
Max. current		A	13.50
MCA		A	13.00
MOP		A	20.00
Compressor	Model		APG020KAC
	Type		scroll
	Capacity	Btu/h	27300.00
	Input	W	1294.00
	Rated current(RLA)	A	5.60
	Locked rotor Amp(LRA)	A	52.00
Outdoor fan motor	Model		DRN-310-200-10
	Rate current	A	1.10
	Input	W	226.00
	Output	W	200.00
	Speed	rpm	850.00
Outdoor air flow		CFM	3060.00
Outdoor noise level		dB(A)	61.00
Throttling type			Piston
Outdoor dimension	Unit (WxHxD)	in	29-1/7×25×29-1/7
	Packing (WxHxD)	in	29-9/10×25-9/10×29-9/10
	Net / Gross weight	lbs	159/168
Refrigerant pipe	Charging	oz	R410A/118.17
Operation temp range	Cooling	°F	58-115
	Heating	°F	15-75
	Heating (high vertical)	°F	23-75

Condenser Model	AHU Model	Capacity	EER2	SEER	SEER2	Capacity(heating)	HSPF
BAH4-24-15	LUC4-24-15	23000.00	11.70	15	14.30	23000	7.50
BAH4-24-15	CWM4-24-15	23000	11.7	15	14.3	23000	7.5

ComfortStar®

12201 N W 107th Avenue
Miami, FL 33178
1.866.524.9898 Toll Free
305.500.9898 Office
305.500.9896 Fax
<http://www.comfortstarusa.com>



The AHRI mark indicates Comfortstar participating in the AHRI Certification program. Visit ahridirectory.org for verification of individual certified products. Comfortstar reserves the right to change design and specs without notice. Comfortstar has a policy of update the data continuously. We are committed to using environmentally conscious print practices.

BAH4-24-15 17th Aug. 2023
Supersedes BAH4-24-15 (Aug.2023)

© 2023 ComfortStar